

IBM System/370

Vector Operations

IBM



IBM System/370

Vector Operations

Publication Number
SA22-7125-1

File Number
S370-01

Second Edition (August 1986)

This edition obsoletes the previous edition, SA22-7125-0. It contains a number of detailed changes, which are indicated by a vertical line in the margin to the left of the change.

Changes are made periodically to the information herein; before using this publication in connection with the operation of IBM equipment, refer to the latest *IBM System/370, 30xx, and 4300 Processors Bibliography*, GC20-0001, for the editions that are applicable and current.

This publication is provided for use in conjunction with other relevant IBM publications, and IBM makes no warranty, express or implied, relative to its completeness or accuracy.

IBM may have patents or pending patent applications covering subject matter described herein. Furnishing this publication does not constitute or imply a grant of any license under any patents, patent applications, trademarks, copyrights, or other rights of IBM or of any third party, or any right to refer to IBM in any advertising or other promotional or marketing activities. IBM assumes no responsibility for any infringement of patents or other rights that may result from the use of this publication or from the manufacture, use, lease, or sale of apparatus described herein.

Licenses under IBM's utility patents are available on reasonable and nondiscriminatory terms and conditions. Inquiries relative to licensing should be directed, in writing, to: Director of Contracts and Licensing, International Business Machines Corporation, Armonk, New York 10504.

References in this publication to IBM products, programs, or services do not imply that IBM intends to make these available in all countries in which IBM operates. Any reference to an IBM product is not intended to state or imply that only IBM's product may be used. Any functionally equivalent product may be used instead.

Publications are not stocked at the address given below. Requests for IBM publications should be made to your IBM representative or to the IBM branch office serving your locality.

A form for readers' comments is provided at the back of this publication. If the form has been removed, comments may be addressed to IBM Corporation, Product Publications, Department B98, PO Box 390, Poughkeepsie, NY, U.S.A. 12602. IBM may use or distribute whatever information you supply in any way it believes appropriate without incurring any obligation to you.

This publication contains, for reference purposes, a detailed definition of the machine functions provided by the IBM System/370 vector facility. The vector facility operates as a compatible extension of the functions of System/370 as described in one of the Principles of Operation publications, either the facilities of the System/370 extended architecture (370-XA) in *IBM 370-XA Principles of Operation*, SA22-7085, or those of the System/370 architecture in *IBM System/370 Principles of Operation*, GA22-7000.

The publication should not be considered an introduction or a textbook. It is written as a reference for use principally by assembler-language programmers, although anyone concerned with the functional details of vector operations may find it useful. It describes each function at the level of detail needed to prepare an assembler-language program which relies on that function.

This publication does not describe all the instructions or other functions needed to write a complete program using vectors. It includes a description only of functions which are added to System/370 as part of the vector facility. The reader is assumed to be familiar with either the *IBM 370-XA Principles of Operation* or *IBM System/370 Principles of Operation*, as appropriate. Terms and concepts referred to in this publication but explained in those Principles of Opera-

tion publications are not explained again in this publication.

Writing a program in assembler language requires a familiarity with the notations and conventions of that language, as well as with the facilities of the operating system under which the program is to be run. The reader should refer to the appropriate programming publications for such information.

Terminology

As used in this publication, a *scalar* is a single data item, which may be a floating-point number, a binary integer, or a set of logical data. A *vector* is a linearly ordered collection of such scalars, where each scalar is an *element* of the vector. All elements of a single vector are of the same type: floating-point numbers (floating-point vector), binary integers (binary vector), or logical data (logical vector).

Scalar instructions are instructions which perform load, store, arithmetic, or logical operations on scalars that may reside in storage, floating-point registers, or general registers. *Vector instructions* perform similar operations on vectors that may reside in storage or in registers of the vector facility. Only vector instructions and related operations are described in this publication. Scalar instructions are described in the *IBM 370-XA Principles of Operation* or *IBM System/370 Principles of Operation*.

Chapter 1. Introduction	1-1	Interruptible Vector	
Compatibility Considerations	1-1	Instructions	2-20
Vector and Scalar Operations	1-1	Units of Operation	2-20
Model-Dependent Vector Functions	1-2	Operand Parameters	2-21
Chapter 2. Vector Facility	2-1	Arithmetic Exceptions	2-21
Vector-Facility Structure	2-1	Exception-Extension Code	2-21
Vector-Data Registers	2-1	Types of Ending for Units of Operation	2-22
Vector Registers	2-1	Effect of Interruptions During Execution	2-23
Vector-Mask Register	2-1	Setting of Instruction Address	2-23
Vector Parameters	2-1	Setting of Instruction-Length Code	2-23
Section Size	2-1	Setting of Storage Address	2-24
Partial-Sum Number	2-2	Setting of Vector Interruption Index	2-25
Vector-Status Register	2-2	Program-Interruption Conditions	2-25
Vector-Mask-Mode Bit	2-3	Access Exceptions for Vector Operands	2-25
Vector Count	2-3	Exponent-Overflow Exception	2-26
Vector Interruption Index	2-3	Exponent-Underflow Exception	2-26
Vector In-Use Bits	2-4	Floating-Point-Divide Exception	2-26
Vector Change Bits	2-4	Specification Exception	2-26
Vector-Activity Count	2-5	Unnormalized-Operand Exception	2-27
Modes of Operation	2-6	Vector-Operation Exception	2-27
Vector-Operation Control	2-6	Priority of Vector Interruptions	2-27
Vector-Instruction Operands and Results	2-7	Program Switching	2-28
Arithmetic Vectors in Storage	2-8	Program Use of the Restore and Save Instructions	2-28
Access by Sequential Addressing	2-8	Restore Operations	2-28
Access by Indirect Element Selection	2-9	Save Operations	2-29
Arithmetic Vectors in Registers	2-10	Clear Operations	2-29
Operands in Vector Registers	2-10	Save-Area Requirements	2-29
Operands in Scalar Registers	2-10	Relationship to Other Facilities	2-30
Bit Vectors	2-10	Program-Event Recording (PER)	2-30
Vector Sectioning	2-11	Vector-Store Operations	2-30
Conditional Arithmetic	2-12	Storage-Operand Consistency	2-30
Vector-Mask Mode	2-12	Storing into Instruction Stream	2-30
Instructions Controlling the Vector-Mask Mode	2-12	Resets	2-31
Common Instruction Descriptions	2-12	Machine-Check Handling	2-31
Instruction Classes	2-13	Vector-Facility Failure	2-31
Instruction Formats	2-13	Vector-Facility Source	2-31
Field Designations	2-13	Validation of Vector-Facility Registers	2-31
Three-Operand Instruction Formats	2-15	Chapter 3. Vector-Facility Instructions	3-1
Summary of Instructions by Class and Format	2-15	ACCUMULATE	3-2
Class-IM and Class-IC Instructions	2-15	ADD	3-3
Class-IM Instructions	2-17	AND	3-4
Class-IC Instructions	2-17	AND TO VMR	3-5
Storage Operands for QST and VST Formats	2-18		
Class-NC Instructions	2-19		
VS-Format Instructions	2-19		
Instructions In Other Classes	2-19		
Vector Interruptions	2-20		

CLEAR VR	3-5
COMPARE	3-6
COMPLEMENT VMR	3-7
COUNT LEFT ZEROS IN VMR	3-8
COUNT ONES IN VMR	3-8
DIVIDE	3-8
EXCLUSIVE OR	3-9
EXCLUSIVE OR TO VMR	3-10
EXTRACT ELEMENT	3-10
EXTRACT VCT	3-11
EXTRACT VECTOR MASK MODE	3-11
LOAD	3-11
LOAD BIT INDEX	3-12
LOAD COMPLEMENT	3-15
LOAD ELEMENT	3-15
LOAD EXPANDED	3-16
LOAD HALFWORD	3-16
LOAD INDIRECT	3-17
LOAD INTEGER VECTOR	3-18
LOAD MATCHED	3-18
LOAD NEGATIVE	3-19
LOAD POSITIVE	3-20
LOAD VCT AND UPDATE	3-20
LOAD VCT FROM ADDRESS	3-21
LOAD VMR	3-22
LOAD VMR COMPLEMENT	3-22
LOAD ZERO	3-22
MAXIMUM ABSOLUTE	3-23
MAXIMUM SIGNED	3-23
MINIMUM SIGNED	3-23
MULTIPLY	3-24
MULTIPLY AND ACCUMULATE	3-25
MULTIPLY AND ADD	3-26
MULTIPLY AND SUBTRACT	3-27
OR	3-28
OR TO VMR	3-29
RESTORE VAC	3-29
RESTORE VMR	3-29
RESTORE VR	3-30
RESTORE VSR	3-31
SAVE CHANGED VR	3-32
SAVE VAC	3-33

SAVE VMR	3-33
SAVE VR	3-34
SAVE VSR	3-34
SET VECTOR MASK MODE	3-35
SHIFT LEFT SINGLE LOGICAL	3-35
SHIFT RIGHT SINGLE LOGICAL	3-35
STORE	3-35
STORE COMPRESSED	3-36
STORE HALFWORD	3-36
STORE INDIRECT	3-37
STORE MATCHED	3-37
STORE VECTOR PARAMETERS	3-38
STORE VMR	3-38
SUBTRACT	3-39
SUM PARTIAL SUMS	3-40
TEST VMR	3-40
ZERO PARTIAL SUMS	3-41

Appendix A. Instruction-Use

Examples	A-1
Operations on Full Vectors	A-1
Contiguous Vectors	A-1
Vectors with Stride	A-2
Vector and Scalar Operands	A-2
Sum of Products	A-3
Compare and Swap Vector Elements	A-4
Conditional Arithmetic	A-4
Exception Avoidance	A-4
Add to Magnitude	A-4
Operations on Sparse Vectors	A-5
Full Added to Sparse to Give Full	A-5
Sparse Added to Sparse to Give Sparse	A-6
Floating-Point-Vector Conversions	A-6
Fixed Point to Floating Point	A-6
Floating Point to Fixed Point	A-7

Appendix B. Lists Of

Instructions	B-1
Index	X-1

The vector facility is a compatible addition to the IBM System/370 architecture. Use of the facility may benefit applications in which a great deal of the time of the central processing unit (CPU) is spent executing arithmetic or logical instructions on data which can be treated as vectors. By replacing loops of scalar instructions with the vector instructions provided by the vector facility, such applications may take advantage of the order inherent in vector data to improve performance.

When the vector facility is provided on a CPU, it functions as an integral part of that CPU:

1. Standard System/370 instructions can be used for all scalar operations.
2. Data formats which are provided for vectors are the same as the corresponding System/370 scalar formats.
3. Long-running vector instructions are interruptible in the same manner as long-running scalar instructions; their execution can be resumed from the point of interruption after appropriate action has been taken.
4. Program interruptions due to arithmetic exceptions are handled in the same way as for scalar-arithmetic instructions, and the same fixup routines can be used with at most some minor extensions.
5. Vector data may reside in virtual storage, with access exceptions being handled in the customary manner.

COMPATIBILITY CONSIDERATIONS

Compatibility with System/370 scalar operations has been one of the major objectives of the vector architecture, so as to provide the same result data when equivalent functions are programmed on machines without the vector facility. Some departures from strict compatibility are introduced, however, for the sake of performance and to provide

implementers of the vector facility more flexibility in making design choices.

Vector and Scalar Operations

Although operations on vector operands are generally compatible, element by element, with the corresponding scalar operations, there are certain differences between the vector and scalar architectures:

- Operands of vector-facility instructions must be aligned on integral boundaries; scalar-instruction operands need not be so aligned. (See the section "Vector-Instruction Operands and Results" on page 2-7.)
- Vector divide and multiply operations do not permit unnormalized floating-point operands; the corresponding scalar instructions do. Vector programs may encounter the *unnormalized operand* exception. (See the instruction descriptions and the section "Unnormalized-Operand Exception" on page 2-27.)
- Because the result of a series of floating-point additions may depend on their sequence, the results produced by the vector instructions ACCUMULATE or MULTIPLY AND ACCUMULATE, followed by SUM PARTIAL SUMS, are not necessarily identical with those produced by scalar summation loops, unless the scalar loops are written to perform the additions in exactly the same sequence as defined for the vector instructions. (See the instruction descriptions and the section "Partial-Sum Number" on page 2-2.)
- If, during execution of MULTIPLY AND ACCUMULATE, MULTIPLY AND ADD, or MULTIPLY AND SUBTRACT, the multiplication of an element pair results in an exponent underflow, a true zero is used in place of the product even when the exponent-underflow mask in the PSW is one. The vector and scalar results are the same, however, when the mask bit is zero

or when an exponent underflow occurs during the addition or subtraction. (See the instruction descriptions and the section "Exponent-Underflow Exception" on page 2-26.)

- Vector-facility instructions cannot safely be used to store into the current instruction stream, whereas all other instructions are interlocked to permit this. (See the section "Vector-Store Operations" on page 2-30.)

Model-Dependent Vector Functions

Programmers should keep the following restrictions in mind to ensure that programs will run successfully regardless of which implementation techniques have been chosen on a particular model.

The program should not depend on specific values of the model-dependent vector parameters (section size and partial-sum number). Likewise, the program should not depend on the contents of fields that are described as "reserved" or "undefined." Specifically:

- The section size should not be treated as a numeric constant. Thus, save-area sizes should be computed from the section-size value obtained at execution time. (See the section "Save-Area Requirements" on page 2-29.) The section size may be obtained by executing the instruction STORE VECTOR PARAMETERS.
- The program should not rely on reserved bits 0-14 of the vector-status register being zeros when placed in a general register by the instruction EXTRACT VECTOR MASK MODE, or on the bits being stored as zeros by SAVE VSR. (See the instruction descriptions "EXTRACT VECTOR MASK MODE" on page 3-11 and "SAVE VSR" on page 3-34.)
- The program should not depend on any particular values being stored by the instruction SAVE VMR in the undefined part of the save area for the vector-mask register; nor should

the program depend on the presence or absence of access exceptions for that portion of the VMR save area when executing RESTORE VMR or SAVE VMR. (See the instruction descriptions "SAVE VMR" on page 3-33 and "RESTORE VMR" on page 3-29.)

- When a program using vector-facility instructions is interrupted, it cannot be safely resumed on another machine with a different section size or partial-sum number, unless the interruption occurred at a point that is known to be independent of the section size or partial-sum number, respectively.
- The exact result produced by the vector instructions ACCUMULATE or MULTIPLY AND ACCUMULATE, followed by SUM PARTIAL SUMS, may depend on the partial-sum number of the model because that number affects the sequence of performing the floating-point additions.

The program should not rely on receiving a specific program interruption, either operation exception or vector-operation exception, to indicate whether the vector facility is installed in any CPU of the configuration, since it depends on the model which of the two exceptions occurs. (See the section "Vector-Operation Control" on page 2-6.)

Problem-state programs should not depend on the setting of the vector change bits, which may be altered by actions of the control program that are unrelated to the actions of a problem-state program. Supervisor-state programs can depend on the accuracy of vector change bits that are zeros; vector change bits may sometimes be set to one, however, even when the corresponding vector-register pair has not been changed. Note also that the effect on the vector change bits of executing the instructions RESTORE VR and RESTORE VSR depends on whether the CPU is in the problem or supervisor state. (See the section "Vector Change Bits" on page 2-4.)

PER events for general-register alteration may or may not be recognized for vector-facility instructions.

VECTOR-FACILITY STRUCTURE

The vector facility provides:

1. The vector-facility registers:
 - 16 vector registers
 - A vector-mask register
 - A vector-status register
 - A vector-activity count
2. 171 instructions
3. The following exceptions and exception indications:
 - An unnormalized-operand exception
 - A vector-operation exception
 - An exception-extension code for arithmetic exceptions
4. A vector-control bit, bit 14 of control register 0

Figure 2-1 on page 2-2 shows the registers provided by the vector facility.

Vector-Data Registers

Vector Registers

There are 16 vector registers, numbered 0-15. They are used to hold one or more of the vector operands in most arithmetic, comparison, logical, load, and store operations. Unlike the general and floating-point registers, the vector registers are multipurpose in that vectors of floating-point, binary-integer, and logical data can all be accommodated.

Each vector register contains a number of element locations of 32 bits each. Depending on the operation, a vector operand may occupy a single vector reg-

ister or an even-odd pair of registers. The element locations of a vector register are identified by consecutive element numbers, starting with 0.

Vector-Mask Register

There is one vector-mask register (VMR), which is used as:

- The target of the result of vector-compare operations,
- The source and target of logical operations on bit vectors, and
- The source of the mask for mask-controlled operations.

Vector Parameters

The section size and the partial-sum number are model-dependent parameters which control certain operations of the vector facility.

Section Size

The number of element locations in a vector register, which is also the number of bit positions in the vector-mask register, is called the section size. The section size is a power of 2; depending on the model, the section size may be 8, 16, 32, 64, 128, 256, or 512.

The element locations of a vector register, as well as the bit positions in the vector-mask register, are numbered from 0 to one less than the section size.

In a multiprocessing configuration, the section size is the same for each CPU which has the vector facility installed.

The section size of a model may be obtained by executing the instruction STORE VECTOR PARAMETERS, which places the value as a 16-bit binary integer in the left half of a word in storage.

Vector Registers

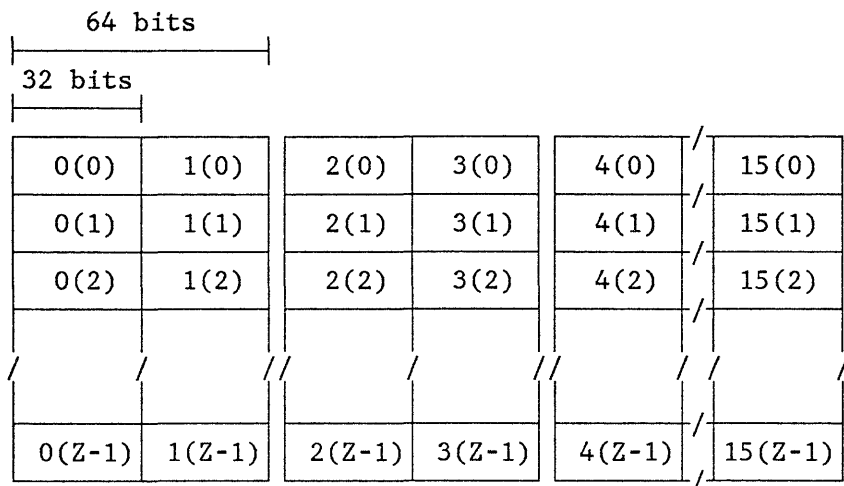

Vector-Mask Register

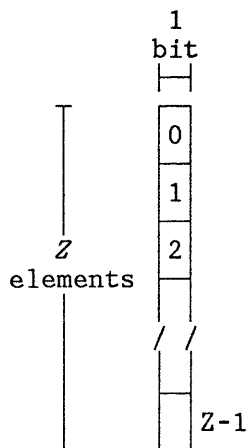

Vector-Status Register

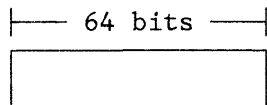

Vector-Activity Count

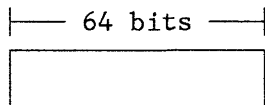

Note: Z is the section size (model-dependent).

Figure 2-1. Registers of the Vector Facility

Partial-Sum Number

The partial-sum number is the number of partial sums produced when executing the instruction ACCUMULATE or MULTIPLY AND ACCUMULATE. It is also the number of vector-register elements set to zero by the instruction ZERO PARTIAL SUMS, as well as the number of vector-register elements summed by the instruction SUM PARTIAL SUMS.

Depending on the model, the partial-sum number may range from 1 up to and including the section size.

In a multiprocessing configuration, the partial-sum number is the same for each CPU which has the vector facility installed.

The partial-sum number of a model may be obtained by executing the instruction STORE VECTOR PARAMETERS, which places the value as a 16-bit binary integer in the right half of a word in storage.

Vector-Status Register

The vector-status register (VSR) is 64 bits long and contains five fields of information, which describe the current status of the vector and vector-mask registers and of a mode of operation. The fields are arranged as follows:

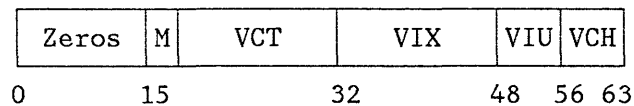

The contents of the vector-status register as a whole may be examined by the instruction SAVE VSR and altered by the instruction RESTORE VSR. Bits 0-14 of the VSR are reserved for possible future use and are stored as zeros by SAVE VSR; if the instruction RESTORE VSR specifies other than all zeros for these bit positions, a specification exception is recognized.

Vector-Mask-Mode Bit

When the vector-mask-mode bit (M), bit 15 of the vector-status register, is one, the vector-mask mode is on, and arithmetic and logical instructions are executed under the control of bits in the vector-mask register. When the bit is zero, the mode is off. For details, see the section "Conditional Arithmetic" on page 2-12.

Vector Count

The vector count (VCT), bits 16-31 of the vector-status register, is a 16-bit unsigned binary integer. Together with the vector interruption index, it determines for most vector operations the number of element locations to be processed in vector registers or the number of bit positions to be processed in the vector-mask register.

Elements in register positions with element numbers less than the vector count are called the active elements of the vector register. Likewise, bits in bit positions of the vector-mask register with bit numbers less than the vector count are called the active bits of the vector-mask register. Only the active elements or bits take part in operations where the number of elements or bits processed is determined by the vector count.

The vector count may range in value from zero up to and including the section size. A specification exception is recognized if the instruction RESTORE VSR attempts to place a value in the vector-count field which exceeds the section size. The instruction EXTRACT VCT may be used to examine the vector count.

The following instructions may be used to set the vector count. If they specify a number greater than the section size, they set the vector count equal to the section size.

```
LOAD BIT INDEX
LOAD VCT AND UPDATE
LOAD VCT FROM ADDRESS
```

For information on using the vector count with vectors of any length, see the section "Vector Sectioning" on page 2-11.

Vector Interruption Index

The vector interruption index (VIX), bits 32-47 of the vector-status register, is a 16-bit unsigned binary integer. It specifies the number of the first element location in any vector register, or of the first bit position in the vector-mask register, to be processed by an interruptible vector instruction which depends on the vector interruption index. The vector interruption index is used to control resumption of the operation after such an instruction has been interrupted. It is normally zero at the start of execution, and it is set to zero at completion.

For details concerning the operation of the vector interruption index and the effect of an interruption, see the section "Vector Interruptions" on page 2-20.

The vector interruption index may range from zero to the section size. It may be examined by using the instruction SAVE VSR, and it may be set explicitly by RESTORE VSR. The instruction CLEAR VR sets the vector interruption index to zero. A specification exception is recognized if the instruction RESTORE VSR attempts to place a value in the vector-interruption-index field which exceeds the section size.

Programming Notes

1. Since the vector interruption index is always set to zero upon completion of any instruction which depends on it, the program normally need not be concerned with setting its value.
2. The vector interruption index may be set to zero explicitly by use of the instruction CLEAR VR with a zero operand.
3. If it is desired to operate on a vector in a vector register starting at other than element location 0, this may be done by first setting the vector interruption index (VIX) to the initial element number. The VIX may be set by using the instruction SAVE VSR to place the current

contents of the vector-status register (VSR) in storage, placing the initial element number in the field which corresponds to the VIX, and then returning the result to the VSR by means of RESTORE VSR. Such modification of the VSR can be performed safely when the CPU is in the problem state. If a program modifying the VSR is to be executed in the supervisor state, however, additional precautions may have to be taken; see the section "Vector Change Bits," programming note 3 on page 2-5.

Vector In-Use Bits

The eight vector in-use bits (VIU), bits 48-55 of the vector-status register, correspond to the eight vector-register pairs 0, 2, 4, 6, 8, 10, 12, and 14.

The vector in-use bits indicate which vector-register pairs are to be saved and restored by SAVE VR and RESTORE VR. These instructions ignore vector-register pairs for which the vector in-use bit is zero.

During execution of instructions which use the vector registers, the vector in-use bit associated with a vector-register pair is set to one whenever any element in either or both of the registers is loaded or modified. When a register is used as the source of an operand, its vector in-use bit remains unchanged.

The vector in-use bits are set by the instruction RESTORE VSR. If that instruction changes a vector in-use bit from one to zero, it causes the corresponding vector-register pair to be cleared to zeros. A vector in-use bit is set to zero when the instruction CLEAR VR clears the corresponding vector-register pair to zeros.

See the section "Program Switching" on page 2-28 for a discussion of the vector in-use bits.

Vector Change Bits

The eight vector change bits (VCH), bits 56-63 of the vector-status register, correspond to the eight vector-register pairs 0, 2, 4, 6, 8, 10, 12, and 14.

The vector change bits indicate which vector-register pairs are to be saved by the privileged instruction SAVE CHANGED VR. That instruction saves a vector-register pair if the corresponding vector change bit is one; it then sets the vector change bit to zero.

If the vector in-use bit associated with a vector-register pair is set to zero by the instruction CLEAR VR or RESTORE VSR, the corresponding vector change bit is also set to zero.

During execution of an instruction which uses the vector registers, the vector change bit associated with a vector-register pair is set to one whenever any element in either or both of the registers is loaded or modified. An exception is the instruction RESTORE VR; when the CPU is in the supervisor state, execution of RESTORE VR leaves the vector change bits unchanged.

When a vector register is used as the source of an operand, its vector change bit remains unchanged.

See the section "Program Switching" on page 2-28 for further discussion of the vector change bits.

Programming Notes

1. The vector change bit is always zero when the vector in-use bit is zero. When the vector change bit is set to one, the vector in-use bit is also set to one.
2. As pointed out in the section "Program Switching" on page 2-28, vector change bits are intended for use by control programs operating in the supervisor state. When the CPU is in the problem state, the value of the vector change bits stored by SAVE VSR is undefined; problem-state programs should, therefore, not depend on the value of these bits.

A program operating in the problem state cannot set a vector change bit

to zero, except by also setting the corresponding in-use bit to zero (clearing the vector-register pair). In the problem state, the instruction RESTORE VSR sets the vector change bit to one for every pair of vector registers whose in-use bit is set to one.

3. If a program uses the instruction RESTORE VSR to modify the contents of the vector-status register while the CPU is in the supervisor state, and the program is subject to interruptions for which the interruption handler may cause a SAVE CHANGED VR instruction to be executed, care must be taken to ensure that the vector change bits reflect all modifications of the active vector registers. A safe procedure is to supply ones in all bit positions of the operand of RESTORE VSR which correspond to the vector change bits. This precaution is unnecessary in the problem state, because RESTORE VSR then sets the vector change bits to ones regardless of the operand.
4. A program operating in the supervisor state can depend on the accuracy of vector change bits that are zeros. When the program is a guest in a virtual-machine environment, however, vector change bits may be overindicated, so that a bit may be set to one even when the corresponding vector-register pair has not been changed.

Vector-Activity Count

The vector-activity count (VAC) provides a means for measuring and scheduling the machine resources used in executing instructions of the vector facility.

The vector-activity count has this format:

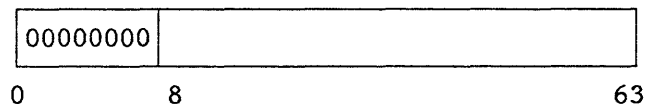

Bits 8-63 are a 56-bit unsigned binary integer. In the basic form, this integer is incremented by adding a one

in bit position 51 every microsecond while a vector-facility instruction is being executed. In models having a higher or lower resolution, a different bit position is incremented at such a frequency that the rate of incrementing the vector-activity count is the same as if a one were added in bit position 51 every microsecond during those periods. Bits 0-7 are zeros.

The contents of the vector-activity count may be obtained by executing the privileged instruction SAVE VAC, and they may be set by means of the privileged instruction RESTORE VAC. Bits 0-7, and any rightmost bit positions which are not incremented, are stored as zeros by SAVE VAC and are ignored by RESTORE VAC.

When incrementing the vector-activity count causes a carry to be propagated out of bit position 8, the carry is ignored, and counting continues from zero. The program is not alerted, and no interruption occurs as a result of the overflow. Except for such wraparound, or an explicit restore or reset operation, the value of the count never decreases.

The vector-activity count is not incremented during execution of the instructions RESTORE VAC and SAVE VAC. In addition, depending on the model, the count may not be incremented during execution of some other short, uninterruptible instructions of the vector facility.

The vector-activity count is incremented only when the CPU is in the operating state.

Programming Notes

1. The vector-activity count is not intended to be a precise measure of vector execution time. The count may or may not advance during the execution of a particular vector-facility instruction. In the aggregate, however, the count reflects the execution time of the vector portion of normal application programs.
2. The format of the vector-activity count has been chosen to permit the use of unnormalized scalar floating-

point instructions to perform fast addition and subtraction of VAC values.

Modes of Operation

The operation of the vector facility is independent of the architectural mode, except for the range of storage addresses which can be specified. The 370-XA architectural mode provides the choice of operating in either a 31-bit or 24-bit addressing mode; the System/370 architectural mode does not. On a CPU which provides both the 370-XA and System/370 modes, vector operations in the System/370 mode are the same as in the 370-XA mode when in the 24-bit addressing mode. Thus, an address size of 24 bits is available in either the 370-XA or System/370 mode, but vector operations with an address size of 31 bits can be performed only in the 370-XA mode. In the System/370 mode, instructions of the vector facility may be executed in both the EC and BC modes.

In both the 370-XA and System/370 modes, vector operations are governed by the vector-control bit.

Vector-Operation Control

When the vector facility is installed and available on a CPU, execution of vector-facility instructions can be completed only if bit 14 of control register 0, the vector-control bit, is one. Executing a vector-facility instruction when the vector-control bit is zero causes a vector-operation exception to be recognized and a program interruption to occur. The initial value of the vector-control bit is zero.

When the vector facility is not installed or not available on this CPU but is installed on any other CPU which is or can be placed in the configuration, executing a vector-facility instruction causes a vector-operation exception to be recognized regardless of the state of the vector-control bit.

If the vector facility is not installed on any CPU which is or can be placed in the configuration, it depends on the model whether executing a vector-facility instruction causes a vector-

operation exception or an operation exception to be recognized.

A vector facility, though installed, is considered not available when it is not in the configuration, when it is in certain maintenance modes, or when its power is off.

Figure 2-2 summarizes the effect of the vector-control bit according to whether the vector facility is installed and whether vector instructions can be executed by the program.

Vector Facility Installed on Another CPU	Vector Facility on This CPU			
	In-stalled	Avail-able	Effect of Vector-Facility Instruction	
			VC = 0	VC = 1
Yes or No	Yes	Yes	VOP	Execute
Yes or No	Yes	No	VOP	VOP
Yes	No	(NA)	VOP	VOP
No	No	(NA)	VOP or OP	VOP or OP

Explanation:

NA Not applicable
 OP Operation exception
 VC Vector-control bit (control register 0, bit 14)
 VOP Vector-operation exception

Figure 2-2. Vector Control

Programming Notes

1. The control program may use the vector-control bit to defer enabling of the CPU for vector operations and to delay allocation of a vector-save area until a program attempts to use the facility by executing its first vector instruction. Because the resulting vector-operation exception nullifies the operation, the instruction address does not need to be adjusted in order to resume the program.
2. The control program may also keep the vector-control bit set to zero

to prevent a program from examining or changing the contents of the vector-facility registers. This may be useful when a program that does not use the vector facility is to be run after a program that does use the facility has been interrupted. If the next program to use the vector registers is the original program, then running the intervening program with the vector-control bit set to zero may eliminate the need for information held in the vector facility to be saved and later restored.

A possible exception is the vector-activity count (VAC). When the vector-control bit is zero, the VAC may or may not be incremented during the brief period of detecting that an instruction requires the vector-operation exception to be recognized. The number of times that the VAC might be stepped in this way is small, however, compared to the counts accumulated during execution of a vector-application program.

3. When a machine check indicating vector-facility failure occurs, the machine has made a previously available vector facility unavailable. Until the cause of the failure is removed and the facility is made available again, attempting to execute a vector instruction causes a vector-operation exception to be recognized even though the vector-control bit is one. (See the section "Vector-Facility Failure" on page 2-31.)

VECTOR-INSTRUCTION OPERANDS AND RESULTS

The vector facility provides for operations on vectors of short (32-bit) and long (64-bit) floating-point numbers, 32-bit signed binary integers, and 32-bit logical data. A few operations deal with vectors of 16- and 64-bit signed binary integers. There are also operations on vectors of individual bits, which are generally used as mask bits.

All binary-arithmetic vector operations treat elements of 32-bit binary integers

as signed; any fixed-point-overflow exceptions are recognized. Binary-comparison operations also deal with 32-bit signed binary integers. Logical vector operations, including shifts, treat elements as 32-bit logical data.

Most instructions which operate on floating-point, binary-integer, or logical vectors use a format that explicitly designates three operands: two source operands and one target operand. The operands may be:

- In storage,
- In a vector register, or a pair of vector registers, or
- In a scalar (general or floating-point) register.

Instructions which use mask bits generally designate an implicit operand in the vector-mask register, and they also may explicitly designate storage, vector-register, and scalar-register operands.

All vector operands in storage must be aligned on integral boundaries. When an instruction requires boundary alignment and the storage operand is not designated on the appropriate boundary, a specification exception is recognized.

An instruction which processes operands in vector or scalar registers must designate a valid register number for each such operand. If an invalid register number is designated, a specification exception is recognized.

Figure 2-3 on page 2-8 summarizes the vector-data formats, the associated operations, and the boundary-alignment and register-number requirements.

Vectors of 16-, 32-, and 64-bit elements containing arithmetic or logical data are collectively referred to as arithmetic vectors. Arithmetic vectors in storage must be on integral boundaries. The elements of arithmetic vectors have the same formats as scalar data of the same data type.

Vectors of individual bits are referred to as bit vectors (see the section "Bit Vectors" on page 2-10).

Data Type	Width in Bits				Alignment Required In Storage	Valid Register Numbers	
	1	16	32	64		Scalar Register	Vector Register
Floating point Short			A		Word	Even FR	Any VR
Long				A	Doubleword	Even FR	Even VR
Binary integer 16-bit signed		S			Halfword	--	Any VR
32-bit signed			B		Word	Any GR	Any VR
64-bit signed				P	--	--	Even VR
Logical			L		Word	Any GR	Any VR
Bit	M				Byte	--	--

Explanation:

-- Does not apply
A All arithmetic, load, and store operations
B Some arithmetic and all load and store operations
FR Floating-point register
GR General register
L Logical and shift operations
M Logical operations on bits in storage and in vector-mask register; comparison results
P 64-bit binary integers, which occur only as the result of a binary multiply operation
S Only load and store operations, which convert between 16 bits in storage and 32 bits in a vector register
VR Vector register

Figure 2-3. Types of Vector Data

Programming Note

Logical-data elements may also be considered as 32-bit unsigned binary integers, but no arithmetic or comparison operations are provided to process such vectors.

Arithmetic Vectors in Storage

Arithmetic vectors in storage may be loaded and stored in one of two ways:

- By sequential addressing (contiguously or with stride)
- By indirect element selection

Most arithmetic, comparison, and logical instructions may also access one of the vector operands directly from storage by sequential addressing. Indirect element selection is available only for load and store operations.

Access by Sequential Addressing

Vector elements are most often accessed in storage in a regular sequence of addresses. The instruction specifies a general register containing the starting address and, optionally, another general register containing the stride. The stride, which is a 32-bit signed binary integer, is the number of element locations by which the operation advances when proceeding from one element to the next. The maximum number of elements to be accessed is specified by the vector count.

A stride of one specifies a contiguous vector, for which successive elements are in adjacent storage locations; this stride is the default when no general register is specified for the stride. A stride of zero causes the same element to be used repeatedly as the storage

operand. A negative stride causes elements to be accessed in a descending sequence of addresses.

During the execution of instructions which access an arithmetic vector in storage sequentially, the starting address contained in the general register is updated as successive elements in storage are accessed. At the end of instruction execution, or at the time of any interruption, the contents of the general register have been updated to the storage address of the next vector element due to be processed if instruction execution had not ended or been interrupted. Likewise, when instructions process a bit vector in storage, the starting address in the general register is updated by the number of bytes accessed during execution.

Such automatic updating of vector addresses is used to process a vector in sections when the vector has more elements than will fit into a vector register. It also assists in resuming instruction execution after an interruption.

For more details on sequential addressing, see the section "Class-IM and Class-IC Instructions" on page 2-15. For more information on sectioning, see the section "Vector Sectioning" on page 2-11.

Programming Note

A contiguous vector is implied when zero is specified in the instruction field that designates the general register containing the stride. This differs from a zero stride, which is specified by placing a value of zero in the general register containing the stride, and which causes reuse of the same element in storage. A zero stride is generally not desired because the scalar form of an instruction is usually faster than repeated use of the same storage location. (See the section "Operands in Scalar Registers" on page 2-10.)

Access by Indirect Element Selection

Indirect element selection permits vector elements to be loaded or stored in an arbitrary sequence. With the instructions used for indirect element selection, LOAD INDIRECT and STORE INDIRECT, the locations of the individual operand elements to be loaded or stored are designated by a vector of element numbers in a vector register. Each such element number indicates the position of the corresponding operand element relative to the start of the operand vector. The number of operand elements accessed, which is also the number of element numbers used for indirect element selection, is equal to or less than the vector count.

The element numbers used for indirect element selection are 32-bit signed binary integers. They may be positive, negative, repeated, and in any order. Successive operand elements are located in storage at addresses $A + w * E(0)$, $A + w * E(1)$, $A + w * E(2)$, ..., where A is the origin of the operand vector in storage, w is the width in bytes (4 or 8) of each element, and $E(0)$, $E(1)$, $E(2)$, ... are the successive element numbers in a vector register.

General-register address updating does not apply to the instructions LOAD INDIRECT and STORE INDIRECT.

Programming Notes

1. For a discussion of address updating, see the programming notes under "Vector Sectioning" on page 2-11.
2. Vectors of element numbers may be stored as 16-bit signed binary integers when the element numbers remain within the range of such integers. The vector instructions LOAD HALFWORD and STORE HALFWORD perform the conversion between the 16-bit and 32-bit formats.
3. Accessing vectors in storage in the arbitrary sequence permitted by indirect element selection may be significantly slower than accessing contiguous vector elements.

Arithmetic Vectors in Registers

Operands in Vector Registers

Any vector register can be designated for a vector of short floating-point numbers, 32-bit signed binary integers, or 32-bit logical data. Even-odd vector-register pairs are coupled to hold long floating-point numbers or the 64-bit signed binary integers which result from binary multiplication.

When a vector register is modified, those elements in the vector register beyond the last element to be modified are left unchanged.

Most operations on floating-point, binary, or logical vectors which may be performed with one vector operand in storage and one operand in a vector register may also be performed with both operands in vector registers. When both operands are in vector registers, the corresponding pairs of elements from each vector-register operand generally have the same element number (but see the descriptions of ACCUMULATE and MULTIPLY AND ACCUMULATE for an exception to this rule).

Operands in Scalar Registers

Operations on floating-point, binary, or logical vectors may specify as one source operand the contents of a scalar register, that is, of a floating-point or general register, the other operand being a vector. This scalar operand is used repeatedly and treated as a vector of identical elements of the same length as the vector operand.

Some vector instructions which obtain one of the source operands from a scalar register also produce a scalar result, which replaces the contents of the same scalar register.

Bit Vectors

A group of bits in contiguous bit positions is called a bit vector. Bit vectors are the operands of logical operations where one of the operands is in the vector-mask register. They are used in operations on arithmetic vectors under mask control.

A bit vector in storage must begin on a byte boundary, but it may end at any bit position, the remaining bits of the rightmost byte being ignored. When the instruction STORE VMR stores a bit vector with the vector count specifying a number of bits that is not a multiple of 8, the final byte stored is padded on the right with zeros.

When used for the control of load and store operations or for arithmetic and logical operations in the vector-mask mode, the appropriate bit vector must first be placed in the vector-mask register. Each bit in the vector-mask register corresponds sequentially, one for one, to an element of one or both of the vector-register operands.

Bit vectors in the vector-mask register are generated or altered by the following vector instructions:

AND TO VMR
COMPARE
COMPLEMENT VMR
EXCLUSIVE OR TO VMR
LOAD VMR
LOAD VMR COMPLEMENT
OR TO VMR

Programming Notes

1. Examples of the use of bit vectors for mask control are shown in Appendix A.
2. Since the section size is a multiple of 8 and bit vectors start on a byte boundary, every section of a bit vector also starts on a byte boundary. Thus, after an instruction has completed processing a full section of bits, the next bit is always the leftmost bit of the byte specified by the updated address.
3. When a bit vector is used as a mask to identify selected elements of an arithmetic vector with one bits and the remaining elements with zero bits, the bit vector is logically equivalent to a vector containing a set of element numbers in ascending sequence, which may be used for indirect selection of the arithmetic-vector elements. The vector of element numbers consists merely of the bit indexes (bit

numbers) of the one bits in the bit vector.

A bit vector may be converted to a vector of element numbers by the instruction LOAD BIT INDEX. This instruction operates directly on a bit vector in storage and produces a vector of element numbers in a vector register; the vector-mask register is not used.

Vector Sectioning

Vector sectioning is a programming technique for processing vectors the length of which may exceed the section size. Such vectors are processed by dividing them into smaller sections and using a loop of instructions, referred to as a sectioning loop, which repeats the appropriate sequence of instructions for all consecutive sections of the specified vectors. To assist with such sectioning, addresses of vector operands in storage and bit-vector parameters are automatically updated, and the instruction LOAD VCT AND UPDATE is provided.

The LOAD VCT AND UPDATE instruction specifies a general register that has initially been loaded with the total number of vector elements to be processed. The instruction sets the vector count to the lesser of the section size and the general-register contents. It also subtracts this value from the current contents of the general register, which then contains the number of elements remaining to be processed during subsequent passes through the sectioning loop.

LOAD VCT AND UPDATE sets the condition code to provide the program with an indication of whether a complete vector has been processed. The program may use the instruction BRANCH ON CONDITION for loop control to repeat the sequence of instructions for each section. A sectioning loop may also be closed by testing the residual count in the general register for zero and branching back to the start of the loop if not zero.

For most vector operations, the program can be written such that sectioning is independent of the section size. There

are occasions, however, when knowledge of the actual section size is desirable; this value is available to the program by executing the instruction STORE VECTOR PARAMETERS.

Programming Notes

1. Examples of sectioning are shown in Appendix A.
2. One method of controlling the vector count for sectioning is to place the instruction LOAD VCT AND UPDATE at the beginning of the loop and an appropriate BRANCH ON CONDITION instruction at the end of the loop. This is usually sufficient because most vector-facility instructions do not set the condition code. If the sectioning loop does contain an instruction that modifies the condition code, the final BRANCH ON CONDITION instruction could be preceded by a LOAD AND TEST instruction to test the general register containing the residual vector count.

Appendix A also illustrates other techniques.

3. If a sectioning loop contains more than one reference to the same vector in storage, such as a load followed later by a store, the program must ensure, by retaining a copy of the current address, that all addresses within the loop which specify the same vector refer to the same section.
4. The instructions which provide indirect element selection, LOAD INDIRECT and STORE INDIRECT, progress one section of element numbers at a time. But sectioning of the vector of element numbers used for addressing is performed by a preceding instruction which loaded or generated the element numbers by means of sequential addressing. The indirect-selection instructions themselves do not provide for address updating. Each element address is computed separately from an element number and from the specified starting address, which remains unchanged.

Conditional Arithmetic

Vector-Mask Mode

The vector-mask mode allows for conditional execution of arithmetic and logical instructions, depending on the mask bits in the vector-mask register.

When the vector-mask mode is in effect, operand elements are processed if they are in positions which correspond to mask bits that are ones. In positions which correspond to zero mask bits, the target locations remain unchanged, no arithmetic or operand-access exceptions are recognized for those positions, the corresponding change bits in storage remain unchanged, and no PER event for storage alteration is indicated. When the vector-mask mode is not in effect, the mask bits are ignored, and all active elements are processed.

The arithmetic and logical vector instructions which are under the control of the vector-mask mode are:

ACCUMULATE
ADD
AND
DIVIDE
EXCLUSIVE OR
LOAD COMPLEMENT
LOAD NEGATIVE
LOAD POSITIVE
MAXIMUM ABSOLUTE
MAXIMUM SIGNED
MINIMUM SIGNED
MULTIPLY
MULTIPLY AND ACCUMULATE
MULTIPLY AND ADD
MULTIPLY AND SUBTRACT
OR
SHIFT LEFT SINGLE LOGICAL
SHIFT RIGHT SINGLE LOGICAL
SUBTRACT

Except for LOAD COMPLEMENT, LOAD NEGATIVE, and LOAD POSITIVE, which are considered arithmetic instructions for this purpose, load and store instructions are not controlled by the vector-mask mode; neither are instructions which modify the vector-mask register, such as COMPARE. LOAD EXPANDED, LOAD MATCHED, STORE COMPRESSED, and STORE MATCHED do depend on the vector-mask register for

their execution, but this is independent of the mode setting.

For more details, see the section "Class-IM and Class-IC Instructions" on page 2-15.

Instructions Controlling the Vector-Mask Mode

The instruction SET VECTOR MASK MODE (VSVMM) turns the vector-mask mode on or off. EXTRACT VECTOR MASK MODE (VXVMM) places the current value of the mode in a general register.

Programming Notes

1. The vector-mask mode is useful when arithmetic vector operations depend on the result of a vector comparison. Only elements which are to be processed are subject to arithmetic and access exceptions.
2. Since loading, comparing, and storing are operations which are not subject to the vector-mask mode, it is frequently possible to leave the vector-mask mode in effect while performing the arithmetic for an entire sectioning loop.

COMMON INSTRUCTION DESCRIPTIONS

Many vector-facility instructions have common characteristics and obey common rules for accessing the elements of their vector operands. This section describes the common aspects, which are not repeated in individual instruction descriptions.

Some instructions contain fields that vary slightly from the basic format, and in some instructions, the operation performed does not follow the general rules stated in this section. Any exceptions to these rules are noted in the individual instruction descriptions, as are the rules for instruction formats and types not covered in this section.

The rules are grouped according to instruction classes and formats.

Programming Note

Many load and all store operations on vectors are the same for binary and short floating-point operands, so that only a single set of operation codes is provided for them. However, for programming convenience, both binary and short floating-point mnemonics are assigned to these operation codes.

Separate operation codes are provided for short floating-point and binary operands when the operation must distinguish between floating-point and general registers, as in loading or extracting an element, or when the operation depends on the data type, such as LOAD COMPLEMENT.

| Instruction Classes

Vector-facility instructions are classified into one of nine classes: IM, IC, IG, IP, IZ, NC, NZ, N1, and N0. The properties of these nine instruction classes are summarized in Figure 2-4.

Instruction Class	Number of Elements or Bits	Execution Interruptible?	Vector-Mask Mode Control?
IM	VCT - VIX	Yes	Yes
IC	VCT - VIX	Yes	No
IG	GR and VIX	Yes	No
IP	PSN - VIX	Yes	No
IZ	SS	Yes	No
NC	VCT	No	No
NZ	SS	No	No
N1	One	No	No
N0	None	No	No

Explanation:

GR Number of bits determined by contents of a general register
 PSN Number of elements determined by partial-sum number
 SS Section size
 VCT Vector count
 VIX Vector interruption index

Figure 2-4. Vector-Facility Instruction Classes

The instruction classes distinguish:

- Whether the instruction is interruptible (I_) or not interruptible (N_),
- Whether instruction execution depends on the vector interruption index (IM, IC, IG, IP),
- Whether instruction execution depends on the setting of the vector-mask mode (IM),
- Whether the number of vector elements or bits processed is variable and is controlled by the vector count (IM, IC, NC) or by a general register (IG),
- Whether the number of vector elements or bits processed is the partial-sum number (IP) or the section size (IZ, NZ),
- Whether just one vector element is processed (N1) or none (N0).

| Instruction Formats

The instruction formats used by vector-facility instructions are shown in Figure 2-5 on page 2-14. The first four are the base formats — QST, QV, VST, and VV, where Q indicates that the format provides for a scalar-register operand, ST indicates a storage operand (with stride), and V indicates a vector-register operand. Most of the arithmetic instructions are available in all four of these base formats. For the vector-comparison instructions, the VR₁ field of the base formats is interpreted as a modifier (M₁).

Bit positions which are shown in instruction formats as shaded (////) are unassigned.

Field Designations

The field designations in the instruction formats indicate the use of the field and the type of operation in which the field participates.

B₂ and D₂ Fields: B₂ designates a base register, and D₂ is a displacement. They are used for addressing in the same way as with scalar instructions.

First Halfword	Second Halfword	Third Halfword
-------------------	--------------------	-------------------

Base Formats

QST Format	Op Code	QR ₃	RT ₂	VR ₁	RS ₂
	0	16	20	24	28 31
QV Format	Op Code	QR ₃	/////	VR ₁	VR ₂
	0	16	20	24	28 31
VST Format	Op Code	VR ₃	RT ₂	VR ₁	RS ₂
	0	16	20	24	28 31
VV Format	Op Code	VR ₃	/////	VR ₁	VR ₂
	0	16	20	24	28 31

Other Formats

RRE Format	Op Code	//////////	GR ₁	/////				
	0	16	24	28 31				
RSE Format	Op Code	R ₃	/////	VR ₁	/////	B ₂	D ₂	
	0	16	20	24	28	32	36	47
S Format	Op Code	B ₂	D ₂					
	0	16	20	31				
VR Format	Op Code	QR ₃	/////	VR ₁	GR ₂			
	0	16	20	24	28 31			
VS Format	Op Code	////////////////////	RS ₂					
	0	16	28	31				

Figure 2-5. Vector-Facility Instruction Formats

FR₃ Field: FR₃ designates a (scalar) floating-point register. It is a more specific description of the QR₃ field used in some instruction descriptions, and the same rules and restrictions apply as for QR₃.

GR Field: GR designates a (scalar) general register or a pair of general registers. Unless otherwise indicated in the individual instruction definitions, the contents of the general registers designated by the GR₁ and GR₂ fields are called the first operand and second operand, respectively. When designating the third operand (GR₃), it is a more specific indication of the QR₃ field used in some instruction descriptions, and the same rules and restrictions apply as for QR₃.

QR₃ Field: QR₃ designates a scalar register, with the operation code determining whether it is a floating-point or general register. In the QST format, the QR₃ field must not designate a general register which is the same as that designated by the RS₂ field; otherwise, a specification exception is recognized. For instructions in the QV or VR formats with only two operands, one a vector and one a scalar, the scalar operand is called the second operand and is designated by a QR₂ field.

R₃ Field: R₃ is shown in individual instruction descriptions as either VR₃, to designate a vector register, or GR₃, to designate a general register.

RS₂ Field: RS₂ designates a general register containing a storage-operand address. The address is updated during execution. The RS₂ field cannot designate the same general register as the RT₂ field or, in the QST format, as the GR₃ or QR₃ field. (Note that the field can designate general register 0.)

RT₂ Field: RT₂ designates a general register containing a stride. The field cannot designate general register 0; if the RT₂ field is zero, a stride of 1 is specified. It also cannot designate the same general register as the RS₂ field.

VR Field: VR designates a vector register or a pair of vector registers. The VR₁, VR₂, and VR₃ fields designate the first, second, and third operands, respectively, in vector registers or pairs of vector registers, as required for the data type specified by the operation code.

Three-Operand Instruction Formats

All nonstore vector instructions which explicitly specify three operands in the QST, QV, RSE, VST, and VV formats use the first-operand location as the target for the result and the second- and third-operand locations for the source operands. These three-operand operations may be shown symbolically as:

$$\text{Operand 1} = \text{Operand 3} \cdot \text{Operand 2}$$

where \cdot represents an arithmetic or logical operation. Operand 1 is always in vector registers. Operand 2 is in

storage or in vector registers. Operand 3 is either in vector registers or in a scalar register. An instruction may specify the same or different vector registers for the target and source operands.

Vector-comparison instructions are similar to these three-operand instructions, except that they designate a modifier (M₁) instead of a first operand (VR₁), and they place the result in the vector-mask register.

Summary of Instructions by Class and Format

Figure 2-6 on page 2-16 briefly lists all instructions of the vector facility according to class and format within the class.

Class-IM and Class-IC Instructions

Most vector instructions are in either class IM or IC. Instructions in both classes are interruptible, the number of elements processed is determined by the vector count, and they depend on the vector interruption index. Class-IM instructions are also under the control of the vector-mask mode; class-IC instructions are independent of the vector-mask mode.

For both classes, the elements of each operand are processed in sequence from element X , where X is the initial value of the vector interruption index (normally zero), to $C-1$, where C is the vector count.

The number of elements that are processed for each operand is called the net count. If C is greater than X , then the net count is $C-X$; otherwise the net count is zero. For vector instructions which combine vector operands with a scalar operand, the scalar operand is considered to be replicated as many times as indicated by the net count.

If the net count is zero at the start of instruction execution, the vector interruption index is set to zero, and execution is completed immediately. No elements are processed, no operand-access exceptions occur, the change bits for any storage operand remain unchanged, and no PER event for storage

Instructions	Class	Instruction Formats When Operands Are				Total
		Long	Short	Binary	Other	
ADD, SUBTRACT	IM	Four ¹	Four ¹	Four ¹		24
AND, EXCLUSIVE OR, OR	IM			Four ¹		12
DIVIDE	IM	Four ¹	Four ¹			8
MULTIPLY	IM	Four ¹	Four ¹²	Four ¹		12
MULTIPLY AND ADD	IM	QST/QV/VST	QST/QV/VST ²			6
MULTIPLY AND SUBTRACT	IM	QST/QV/VST	QST/QV/VST ²			6
MULTIPLY AND ACCUMULATE	IM	VST/VV	VST/VV ²			4
ACCUMULATE	IM	VST/VV	VST/VV ²			4
LOAD COMPLEMENT	IM	VV	VV	VV		3
LOAD NEGATIVE, LOAD POSITIVE	IM	VV	VV	VV		6
SHIFT LEFT SINGLE LOGICAL	IM			RSE		1
SHIFT RIGHT SINGLE LOGICAL	IM			RSE		1
MAXIMUM ABSOLUTE	IM	VR	VR			2
MAXIMUM SIGNED, MINIMUM SIGNED	IM	VR	VR			4
COMPARE	IC	Four ¹	Four ¹	Four ¹		12
LOAD, LOAD MATCHED	IC	QV/VST/VV	QV/VST ³ /VV ³	QV		14
STORE, STORE MATCHED	IC	VST	VST ³			4
LOAD EXPANDED, STORE COMPRESSED	IC	VST	VST ³			4
LOAD INTEGER VECTOR	IC			VST		1
LOAD HALFWORD, STORE HALFWORD	IC			VST		2
LOAD ZERO	IC	VV	VV ³			2
LOAD INDIRECT, STORE INDIRECT	IC	RSE	RSE ³			4
LOAD BIT INDEX	IG			RSE		1
SUM PARTIAL SUMS	IP	VR				1
ZERO PARTIAL SUMS	IP	VR				1
RESTORE VR	IZ				RRE	1
SAVE VR, SAVE CHANGED VR	IZ				RRE	2
RESTORE VSR	IZ				S	1
CLEAR VR	IZ				S	1

Figure 2-6 (Part 1 of 2). Summary of Vector-Facility Instructions by Class and Format

alteration is indicated. Vector, floating-point, and general registers that are due to be modified, the vector in-use bits, and the vector change bits remain unchanged.

If the instruction is interrupted during execution, $Y-X$ pairs of elements have been processed, where X and Y are the values of the vector interruption index at the beginning of execution and at the time of interruption, respectively. Y is then the element number of the next

element, if any, to be processed for each operand.

When a class-IM or class-IC instruction designates a scalar register as the location of the third operand (in the QST or QV format), and the scalar register is a floating-point register, the instruction must designate register 0, 2, 4, or 6 in the third-operand field; otherwise, a specification exception is recognized.

Instructions	Class	Instruction Formats When Operands Are				Total
		Long	Short	Binary	Other	
COUNT LEFT ZEROS IN VMR	NC				RRE	1
COUNT ONES IN VMR	NC				RRE	1
COMPLEMENT VMR, TEST VMR	NC				RRE	2
AND TO VMR, EXCLUSIVE OR TO VMR	NC				VS	2
LOAD VMR, LOAD COMPLEMENT VMR	NC				VS	2
OR TO VMR, STORE VMR	NC				VS	2
RESTORE VMR, SAVE VMR	NZ				S	2
EXTRACT ELEMENT, LOAD ELEMENT	N1	VR	VR	VR		6
EXTRACT VCT	NO				RRE	1
EXTRACT VECTOR MASK MODE	NO				RRE	1
LOAD VCT AND UPDATE	NO				RRE	1
LOAD VCT FROM ADDRESS	NO				S	1
RESTORE VAC, SAVE VAC, SAVE VSR	NO				S	3
SET VECTOR MASK MODE	NO				S	1
STORE VECTOR PARAMETERS	NO				S	1
Totals		53	51	41	26	171

Explanation:

- ¹ Four instruction formats are provided: QST, QV, VST, and VV.
- ² Operand 1 is in the long format; operands 2 and 3 are in the short format.
- ³ Instruction in this format may be used for both short and binary operands.

Figure 2-6 (Part 2 of 2). Summary of Vector-Facility Instructions by Class and Format

Class-IM Instructions

For instructions in class IM, all elements are processed as described above when the vector-mask mode is off. When the vector-mask mode is on, however, operand elements are fetched from storage or from operand registers, and result elements are placed in the target register, only for those elements which correspond to ones in the vector-mask register. Element positions in the target register corresponding to zeros remain unchanged; no arithmetic or operand-access exceptions are recognized for those positions, the corresponding change bits in storage remain unchanged, and no PER event for storage alteration is indicated.

The first mask bit used, when the vector-mask mode is on, is bit *X* of the vector-mask register, corresponding to the first vector-register element *X*. The last mask bit and vector-register

element processed are numbered *C*-1, if the instruction is completed, or *Y*-1, if the instruction is interrupted during execution.

Class-IM instructions in the QST and VST formats have the storage address in the RS₂ register updated during execution for every element position, regardless of whether the corresponding mask bit is one or zero (see the section "Storage Operands for QST and VST Formats" on page 2-18).

Class-IC Instructions

Execution of instructions in class IC is independent of the vector-mask mode. The following instructions depend on mask bits in the vector-mask register, but their execution is the same whether the vector-mask mode is on or off: LOAD EXPANDED, LOAD MATCHED, STORE COMPRESSED, and STORE MATCHED. The first

mask bit used for those instructions is bit X , corresponding to the first vector-register element X . The last mask bit and vector-register element processed are numbered $C-1$, if the instruction is completed, or $Y-1$, if the instruction is interrupted during execution.

Storage Operands for QST and VST Formats

In the QST and VST formats, the RS_2 field designates a general register containing the starting address, that is, the address of the first element of the vector operand in storage which is to be processed. The RT_2 field, if not zero, designates a general register containing the stride; if the RT_2 field is zero, general register 0 is not used, and a stride of one is assumed.

The addresses of successive vector elements in storage are A , $A+wT$, $A+2wT$, ..., where A is the starting address, T is the stride, and w is the size of each element in bytes. The value of w is 2, 4, or 8, depending on whether the operation code specifies the storage-operand elements to be halfwords, words, or doublewords.

Each address may be obtained by adding to the previous address the value wT , which is the stride T shifted to the left by one, two, or three bit positions. Any carries or ones shifted out of bit position 0 are ignored. Depending on whether the address size is 31 or 24 bits, the rightmost 31 or 24 bits of the sum are used as the storage address, which is also returned to the general register containing the initial address; the leftmost one or eight bit positions, respectively, of the register are set to zeros. The register is thus updated after each unit of operation to hold the address of the next element, whether an element of the storage operand has been accessed or not. All bits in the general register containing the stride take part in the operation, with the contents of the stride register remaining unchanged.

A stride of zero ($T=0$) means that the same element location is used repeatedly. When storing with a zero stride, only the last element stored is retained in the addressed location.

The RT_2 field must be zero and must not designate the same general register as the RS_2 field; likewise, the third-operand field of a QST-format instruction must not designate the same general register as the RS_2 field. Otherwise, a specification exception is recognized, and the operation is suppressed.

No storage accesses are made for elements that are skipped when the stride is not one. If no elements are processed because the net count is zero at the start of instruction execution, no access exceptions are recognized for the storage operand, the change bits for the operand remain unchanged, and no PER event for storage alteration is indicated.

The contents of the RS_2 register remain unchanged when the address is not updated because the net count is zero. When the net count is not zero and one or more elements have been accessed, the address is updated, and the leftmost bits of the RS_2 register, depending on the address size, are set to zeros, even if the stride is zero.

For the instructions LOAD EXPANDED and STORE COMPRESSED, when the net count is not zero and the active bits of the vector-mask register starting with bit X are all zeros, X being the initial value of the vector interruption index, no operand storage accesses are made and the address in the RS_2 register is not updated. It is undefined in that case whether the leftmost one or eight bits of the RS_2 register, depending on the address size, are set to zeros or remain unchanged.

When class-IM instructions are executed with the vector-mask mode on, no access exceptions are recognized for elements corresponding to zeros in the vector-mask register.

Programming Notes

1. For instructions which produce a vector result, result elements corresponding to ones in the vector-mask register are the same whether the vector-mask mode is on or off. The vector-mask mode does affect the results produced by instructions which reduce vector operands to a partial sum (ACCUMULATE and MULTIPLY

AND ACCUMULATE) or to a single scalar result, because those results may depend on the presence or absence of each operand element.

2. The address-updating operation consists of unsigned shifts and additions of binary integers without overflow. Nevertheless, it is useful to consider the stride as a signed quantity, because adding the two's complement of an integer to an unsigned binary number is the same as subtracting that integer.

Class-NC Instructions

Class-NC instructions process a variable number of bits in the vector-mask register but do not process any arithmetic-vector elements. The number of bits processed is determined by the vector count. The instructions are not interruptible and do not depend on the vector interruption index.

Class-NC instructions use the RRE or VS format. Class-NC instructions in the RRE format operate on bits in the vector-mask register. Class-NC instructions in the VS format operate on bits in the vector-mask register and on a bit vector in storage.

When instruction execution is completed for an operation that modifies the contents of the vector-mask register, any remaining rightmost bits of the register are set to zeros.

When the vector count is zero, execution of the instruction is completed without any bits being processed. For an instruction of a type that modifies bits in the vector-mask register when the vector count is not zero, a vector count of zero causes all bits of the vector-mask register to be set to zeros. Any general register due to be modified remains unchanged.

VS-Format Instructions

The VS format is used for instructions which operate on bit vectors in storage and in the vector-mask register. All VS-format instructions are in class NC.

The RS₂ field designates a general reg-

ister that contains the storage address of the first byte of the second operand, the leftmost bit of which is the first bit of the storage operand to be processed. The first bit in the vector-mask register is the leftmost bit, bit 0. The operation proceeds with successive bits in contiguous bit locations of the second operand and in the vector-mask register.

When instruction execution is completed, the address of what would have been the next byte of the second operand is placed in the general register designated by RS₂; that address is the integral part of the expression $A + (C+7)/8$, where A is the starting address in the RS₂ register and C is the vector count. The updated address occupies the rightmost 31 or 24 bit positions of the RS₂ register, depending on the address size; the leftmost bit or eight bits, respectively, are set to zeros.

If the vector count is not a multiple of 8, the remaining bits in the last byte used in storage are ignored on fetching and set to zeros on storing.

If no bits are processed because the vector count is zero, the contents of the RS₂ register remain unchanged, no access exceptions are recognized for the storage operand, the change bits for the operand remain unchanged, and no PER event for storage alteration is indicated.

Programming Note

Only class-NC instructions which modify the vector-mask register set bits beyond the active bits to zeros. This contrasts with COMPARE (class IC), which leaves bits in the vector-mask register beyond the active bits unchanged, and RESTORE VMR (class NZ), which ignores the vector count and replaces all the bits.

Instructions In Other Classes

Details of instructions in classes IG, IP, IZ, NZ, N1, and N0 are contained in the individual instruction definitions.

VECTOR INTERRUPTIONS

Interruptible Vector Instructions

All instructions which can operate on multiple elements of arithmetic vectors in storage or in vector registers are interruptible. Their execution generally consists of multiple units of operation with interruptions being permitted between these units of operation.

Vector instructions which can operate on only one arithmetic-vector element, or on none at all, are not interruptible; that is, the entire execution consists of one unit of operation. They include instructions which operate on multiple bits in the vector-mask register but not on elements of arithmetic vectors.

Conceptually, vector instructions are executed sequentially, elements of the vector operands of a single vector instruction are processed sequentially, and any resulting exceptions are recognized sequentially. Any program interruption is due to the first exception which is recognized and for which interruptions are allowed.

At the time of an interruption, changes to register contents, which are due to be made by an interruptible vector instruction beyond the point of interruption, have not yet been made. Changes to storage locations, however, which are due to be made by an interruptible vector instruction beyond the point of interruption, may have occurred for one or more storage locations beyond the location containing the element identified by the interruption parameters, but not for any location beyond the last element specified by the instruction and not for any locations for which access exceptions exist. Changes to storage locations or register contents which are due to be made by instructions following the interrupted instruction have not yet been made at the time of interruption.

If an instruction is due to cause more than one program interruption other than for PER events, only the first one is indicated.

Units of Operation

The execution of an interruptible vector instruction is considered to be divided into units of operation, such that an interruption is permitted between these units of operation.

The unit of operation for program interruptions, other than for PER events alone, is one vector element. After the last vector element has been processed without a program interruption, the instruction is completed in a final unit of operation. This final unit of operation consists in advancing the instruction address to the next instruction, setting the vector interruption index to zero if the instruction depends on the vector interruption index, and, for some instructions, setting the condition code.

Performing the final unit of operation cannot create any program-interruption conditions. If a program interruption occurs while processing the last element of a vector, the instruction remains partially completed, because the final unit of operation has not yet been performed. Thus, all elements of a vector are processed alike, including the recognition of any program exceptions.

Only the final unit of operation of advancing the instruction address, setting the vector interruption index to zero, and possibly setting the condition code is performed without processing any elements, when an interruptible instruction which depends on the vector interruption index is executed in the following situations:

- For class-IM and class-IC instructions, the vector interruption index equals or exceeds the vector count.
- For the class-IP instructions SUM PARTIAL SUMS and ZERO PARTIAL SUMS, the vector interruption index equals or exceeds the partial-sum number.
- For the class-IG instruction LOAD BIT INDEX, the specified bit count is zero, or the vector interruption index equals the section size.

For interruptions due to an asynchronous condition (external, I/O, repressible machine-check, or restart), the unit of operation may be one or more elements,

depending on the model, the particular instruction, and the condition causing the interruption. If a PER event is held pending at the time an instruction is due to be interrupted by such an asynchronous condition, a program interruption for the PER event occurs first, and the other interruptions occur subsequently (subject to the mask bits in the new PSW) in the normal priority order.

PER events alone do not normally cause execution of a vector instruction to be interrupted prematurely. For possible exceptions, see the subsection "Priority of Indication" of the section "Program-Event Recording" in Chapter 4, "Control," of *IBM 370-XA Principles of Operation* and *IBM System/370 Principles of Operation*.

Operand Parameters

Execution of interruptible vector instructions involves the updating of information referred to as the operand parameters. The operand parameters include:

- The vector interruption index, for instructions which depend on that index,
- The storage address in a general register, for instructions in the QST and VST formats,
- The bit index and bit count in a general register, for LOAD BIT INDEX,
- The floating-point scalar operand, for MAXIMUM ABSOLUTE, MAXIMUM SIGNED, MINIMUM SIGNED, and SUM PARTIAL SUMS,
- The element numbers in a general-register pair, if specified, for MAXIMUM ABSOLUTE, MAXIMUM SIGNED, and MINIMUM SIGNED,
- The vector in-use bits, for CLEAR VR and RESTORE VSR, and
- The save-area address and element number in general registers, for RESTORE VR, SAVE CHANGED VR, and SAVE VR.

Upon interruption, the operand parameters are adjusted so as to indicate the

extent to which instruction execution has been completed. If the instruction is reexecuted after the interruption, execution resumes from the point of interruption.

Arithmetic Exceptions

The arithmetic exceptions which may be caused by interruptible vector instructions are:

- Exponent overflow
- Exponent underflow
- Fixed-point overflow
- Floating-point divide
- Significance
- Unnormalized operand

In the following respects, the arithmetic exceptions are the same for vector instructions as for the corresponding scalar instructions: the program mask in the PSW controls the occurrence of a program interruption for fixed-point overflow, exponent underflow, or significance; the result for the current target element is the same as the result for the corresponding scalar operation; and bits 8-15 of the program-interruption code indicate the type of exception.

The binary ADD, LOAD COMPLEMENT, LOAD POSITIVE, and SUBTRACT instructions for vectors do not indicate fixed-point overflow when a program interruption is disallowed by the fixed-point-overflow mask in the PSW, unlike the corresponding scalar instructions which can indicate overflow by setting the condition code. Other differences, including the definition of the unnormalized-operand exception, which does not apply to scalar instructions, are described in the following sections.

Exception-Extension Code

When an arithmetic exception is recognized during execution of an interruptible vector instruction, a nonzero exception-extension code is stored in bits 0-7 of the program-interruption code. The exception-extension code indicates whether the interruption was due to a noninterruptible scalar instruction or an interruptible vector instruction, whether the result, if any, was placed in a scalar or vector reg-

ister, the width of the result, and the number of the register.

The arithmetic-partial-completion bit, bit 0 of the program-interruption code, indicates that the exception-extension code has been stored. If the arithmetic exception is due to an interruptible vector instruction and causes an interruption which leaves instruction execution partially completed, bit 0 is set to one, and bits 1-7 contain further information. If a scalar instruction was executed, bits 0-7 are set to all zeros.

If not all zeros, the information in the exception-extension code is as follows:

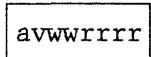

0 7

Bit 0 (a) is the arithmetic-partial-completion bit; when one, it indicates that the interrupted instruction was partially completed and that bits 1-7 have the meaning shown below. If bit 0 is zero, bits 1-7 are also zeros.

Bit 1 (v), when one, indicates that the arithmetic result is in vector registers. When bit 1 is zero, the arithmetic result is in a scalar register.

Bits 2-3 (ww) contain the width of the arithmetic result:

- 01 4-byte result (short or binary)
- 10 8-byte result (long or binary multiply)

Bits 4-7 (rrrr) contain the register number of the result register designated by the interrupted instruction.

Types of Ending for Units of Operation

When execution of an interruptible vector instruction is interrupted, the current unit of operation may end in one of five ways: completion, inhibition, nullification, suppression, or termination. Termination of a unit of operation of a vector instruction causes termination of the instruction; it can occur only as the result of an exigent

machine check and will not be discussed further.

When an interruption occurs after completion, inhibition, nullification, or suppression of a unit of operation, all prior units of operation have been completed. The effect of the interruption on the instruction address in the old PSW stored during the interruption, on the operand parameters, and on the result location for the current unit of operation is as follows:

Completion: The instruction address in the old PSW designates the interrupted instruction or an EXECUTE instruction, as appropriate. The result location for the current unit of operation contains the new result, as defined for the type of exception. The operand parameters are adjusted such that, if the instruction is reexecuted, execution of the interrupted instruction is resumed with the next unit of operation.

Inhibition: Same as completion, except that the result location for the current unit of operation remains unchanged. The exception-extension code is stored the same as if a result had been placed in that location.

Nullification: The instruction address in the old PSW designates the interrupted instruction or an EXECUTE instruction, as appropriate. The result location for the current unit of operation remains unchanged. The operand parameters are adjusted such that, if the instruction is reexecuted, execution of the interrupted instruction is resumed with the current unit of operation. Interruption occurs before any arithmetic operation on the current element has started. Because access exceptions which nullify execution may be recognized for elements beyond the current unit of operation, access to the current element may or may not be the cause of the exception.

Suppression: Same as nullification, except that the instruction address in the old PSW designates the next sequential instruction. Because access exceptions which suppress execution may be recognized for elements beyond the current unit of operation, access to the current element may or may not be the cause of the exception.

The following chart summarizes the differences between the four types of ending for a unit of operation:

Unit of Operation Is	Instruction Address	Operand Parameters At	Current Result Location
Completed	Current Instruct.	Next Element	Changed
Inhibited	Current Instruct.	Next Element	Unchanged
Nullified	Current Instruct.	Current Element	Unchanged
Suppressed	Next Instruction	Current Element	Unchanged

Programming Notes

1. After a program interruption due to an arithmetic exception, an interruption handler may perform any desired fixup of the result before resuming execution of the program.
2. When an instruction which depends on the vector interruption index is interrupted because of an arithmetic exception for the last element to be processed by the instruction, and the instruction is later reexecuted, it is completed by advancing the instruction address, setting the vector interruption index to zero, and possibly setting the condition code, without further processing or program interruptions for this instruction. The same may happen after the vector interruption index has been set to too high a value by the instruction RESTORE VSR.

If the last element processed before an interruption due to an arithmetic exception is the last element of the vector register, then the vector interruption index contains the section size.
3. The floating-point-divide and unnormalized-operand exceptions are defined to inhibit execution of the current unit of operation. Inhibition differs from completion only in

that no result is defined for these exceptions, and that the result location for the current element remains unchanged. Inhibition differs from nullification in that an arithmetic operation has been performed for the current element and the operand parameters have been adjusted to point to the next element.

4. When an arithmetic exception is recognized and bit 1 of the exception-extension code is one, the number of the associated result element in the vector registers is always one less than the current vector interruption index, since all arithmetic exceptions cause either completion or inhibition of the current unit of operation.

Effect of Interruptions During Execution

Interruptions occurring before instruction execution has begun, or after completion of the entire instruction, are the same as for nonvector instructions.

The effect of interruptions which occur during execution of vector-facility instructions depends on the type of ending. Figure 2-7 on page 2-24 shows the effect for each interruption type that can occur during execution.

Setting of Instruction Address

The instruction address in the old PSW designates the interrupted vector-facility instruction or an EXECUTE instruction, as appropriate, after completion, inhibition, or nullification of a unit of operation. The instruction address designates the next sequential instruction after suppression of a unit of operation.

Setting of Instruction-Length Code

When a program interruption occurs during the execution of an interruptible vector instruction, the instruction-length code (ILC) that is stored is 2 or 3, depending on whether the instruction length is two or three halfwords, respectively. When the vector instruction is executed under the control of an

Type of Interruption	Type of Ending	Except. Extens. Code Stored?
<i>Program</i>		
Addressing	S	No
Exponent overflow	C	Yes
Exponent underflow	C	Yes
Fixed-point overflow	C	Yes
Floating-point divide	I	Yes
Page translation	N	No
Protection	S	No
Segment translation	N	No
Significance	C	Yes
Translation specification	S	No
Unnormalized operand	I	Yes
PER event alone	C	No
PER event with another exception	E	E
<i>External, I/O, Repressible Machine Check, and Restart</i>		
All	C	No
<i>Explanation:</i>		
C Completed unit of operation		
E Action determined by the exception reported with the PER event		
I Inhibited unit of operation		
N Nullified unit of operation		
S Suppressed unit of operation		

Figure 2-7. Interruptions during Execution of Interruptible Vector-Facility Instructions

EXECUTE instruction, the ILC is always 2.

The ILC is stored as described regardless of whether the instruction address is advanced to the next instruction (the unit of operation is suppressed) or the instruction address designates the interrupted instruction (the unit of operation is completed, inhibited, or nullified).

For information on the ILC setting for a program interruption that occurs while fetching the instruction, see the section "Instruction-Length Code" in Chapter 6, "Interruptions," of *IBM 370-XA Principles of Operation* and *IBM System/370 Principles of Operation*.

Programming Note

Unless an interruption occurs during instruction fetching and prevents interpretation of the instruction, the instruction-length code is determined entirely by the leftmost two bits of the operation code. The ILC value does not depend on whether the operation code is assigned, or whether the instruction is installed or executed. Thus, the ILC is set to 2 or 3 for a vector instruction, depending on the instruction length, even when a vector-operation exception or an operation exception is recognized.

Setting of Storage Address

When a vector-facility instruction which updates a vector-operand address in a general register is interrupted, the address in the general register has been updated to the point of interruption.

After completion or inhibition of a unit of operation, the updated address designates the next operand element in storage following the one causing the interruption.

After nullification or suppression of a unit of operation, the updated address designates the current operand element; this may or may not be the same as the element that caused the interruption, because of access exceptions which may be recognized for elements beyond the last one processed. If the exception occurs before the first element has been processed, the entire instruction is nullified or suppressed, and the general register containing the storage address remains unchanged.

When the entire instruction has been completed before an interruption takes place, the updated address designates the operand element following the last element processed.

Setting of Vector Interruption Index

At the start of execution of an interruptible vector instruction which depends on the vector interruption index, the vector interruption index contains the number of the next element to be processed in the designated vector registers or the vector-mask register. When such an instruction is interrupted, the vector interruption index is set to indicate the element within the registers at which execution may subsequently be resumed.

After completion or inhibition of a unit of operation, the vector interruption index identifies the next element, if any, to be processed after the one causing the interruption.

After nullification or suppression of a unit of operation, the vector interruption index identifies the current element; this may or may not be the element which caused the interruption, because of access exceptions which may be recognized for elements beyond the last one processed.

During the final step of completing the entire instruction, the vector interruption index is set to zero. This final step cannot cause any further interruptions.

When the entire instruction is nullified or suppressed, the vector interruption index remains unchanged. It also remains unaffected by the interruption of interruptible vector-facility instructions which do not depend on the vector interruption index and which do not set it explicitly. The vector interruption index is explicitly set to zero by CLEAR VR and to a specified value by RESTORE VSR.

Programming Notes

1. Proper resumption of an interrupted instruction depends on the vector interruption index and the appropriate general registers being left unchanged.
2. If it is desired not to resume a program that was interrupted during execution of a vector-facility instruction but, instead, to store the current vector-register contents

by means of vector-store instructions, or to load different data using vector-load instructions, care must be taken to set the vector interruption index to zero explicitly. This may be done with a CLEAR VR instruction; specifying a second operand of zeros leaves the vector-register contents unchanged.

Program-Interruption Conditions

When the vector facility is installed, two additional program exceptions can occur: unnormalized operand and vector operation. A vector-operation exception may also occur on CPUs without the vector facility. All arithmetic exceptions for vector instructions cause an exception-extension code to be stored as part of the program-interruption code. There are also modifications to access exceptions and to some of the arithmetic exceptions, and additional causes for the specification exception.

Access Exceptions for Vector Operands

When a vector-facility instruction specifies an arithmetic or bit vector in storage, access exceptions may be recognized for one or more storage locations beyond the location containing the element being processed, but not for any location beyond the last element specified by the instruction.

For contiguous operands, that is, for arithmetic vectors which are addressed sequentially with a stride of one and for bit vectors, access exceptions are not recognized more than 2K bytes beyond the current location. For noncontiguous operands, that is, for vectors which are addressed sequentially with a stride not equal to one and those which are loaded or stored by indirect element selection, access exceptions are not recognized more than seven element locations beyond the current one.

No access exceptions are recognized for the storage location of an operand when:

- No vector elements are to be processed because the net count is zero,
- The instruction operates under the control of the vector-mask register and the location of a vector element

in storage corresponds to a zero mask bit,

- For the instruction LOAD BIT INDEX, the specified bit count is zero or the vector interruption index equals the section size,
- For the instructions RESTORE VR and SAVE VR, the vector in-use bit associated with the specified vector-register pair is zero, or
- For the instruction SAVE CHANGED VR, the vector change bit associated with the specified vector-register pair is zero.

Programming Note

Interruptible nonvector instructions, such as MOVE LONG, permit access exceptions to be recognized no more than 2K byte locations beyond the location of the byte being processed, which permits access exceptions for a maximum of four operand pages, two for each operand. This is in addition to access exceptions during instruction fetching of up to four pages when the instruction is the target of EXECUTE. Interruptible vector instructions permit access exceptions to be recognized for up to eight operand pages, in addition to a possible four instruction pages. The eight operand pages are not necessarily contiguous.

Exponent-Overflow Exception

If, during execution of a MULTIPLY AND ACCUMULATE, MULTIPLY AND ADD, or MULTIPLY AND SUBTRACT instruction, the multiplication of an element pair results in an exponent overflow, only the multiplication part of the unit of operation is completed, and the addition or subtraction part is not performed. The unit of operation is completed by placing the overflowed product, as defined for the corresponding scalar floating-point multiply instruction, in the result location.

Exponent-Underflow Exception

If, during execution of a MULTIPLY AND ACCUMULATE, MULTIPLY AND ADD, or MULTIPLY AND SUBTRACT instruction, the multiplication of an element pair results in an exponent underflow, no interruption occurs, regardless of the value of the exponent-underflow mask in the PSW. In this case, a true zero is added in place of the product, and the operation continues.

Floating-Point-Divide Exception

When a floating-point-divide exception is recognized during execution of a vector floating-point DIVIDE instruction, the unit of operation is inhibited.

Specification Exception

Specification exceptions are recognized for the following causes in addition to the causes listed in the section "Specification Exception" of Chapter 6, "Interruptions," of *IBM 370-XA Principles of Operation* and *IBM System/370 Principles of Operation*.

- An invalid vector-register number is designated by a VR field of a vector instruction.
- The stride of an instruction in the QST or VST format is specified to be in the same general register as the storage address.
- The third operand of an instruction in the QST format is specified to be in the same general register as the storage address.
- The instruction RESTORE VSR attempts to load values into the vector-status register that are
 1. Other than all zeros in bits 0-14,
 2. Greater than the section size in the vector-count field (bits 16-31), or
 3. Greater than the section size in the vector-interruption-index field (bits 32-47).

- The instruction RESTORE VR, SAVE CHANGED VR, or SAVE VR specifies a number in the element-number field that is equal to or greater than the section size, or a number in the VR-pair field that is other than an even number from 0 to 14.
- The instruction EXTRACT ELEMENT or LOAD ELEMENT specifies an element number in the second operand that is equal to or greater than the section size.

Unnormalized-Operand Exception

An unnormalized-operand exception is recognized when, in a vector floating-point divide or multiply operation, a source-operand element has a nonzero fraction with a leftmost hexadecimal digit of zero. The vector floating-point instructions which may cause an unnormalized-operand exception to be recognized are DIVIDE, MULTIPLY, MULTIPLY AND ACCUMULATE, MULTIPLY AND ADD, and MULTIPLY AND SUBTRACT.

The unnormalized-operand exception is recognized for one operand element even when there is another operand that is zero, except that the floating-point-divide exception, which takes precedence, is recognized instead when the zero element is the divisor of a vector DIVIDE instruction.

The unit of operation is inhibited.

The instruction-length code is 2.

The interruption code is XX1E hex, or XX9E hex with a concurrent PER event, where XX is the exception-extension code.

Vector-Operation Exception

A vector-operation exception is recognized when a vector-facility instruction is executed while bit 14 of control register 0 is zero on a CPU which has the vector facility installed and available. The vector-operation exception is also recognized when a vector-facility instruction is executed and the vector facility is not installed or available on this CPU, but the facility can be made available to the program either on

this CPU or on another CPU in the configuration.

When a vector-facility instruction is executed, and the vector facility is not installed on any CPU which is or can be placed in the configuration, it depends on the model whether a vector-operation exception or an operation exception is recognized.

The operation is nullified when the vector-operation exception is recognized.

The instruction-length code is 2 or 3.

The interruption code is 0019 hex, or 0099 hex with a concurrent PER event.

Programming Note

The definition permits a vector-operation exception to occur even when no CPU in the configuration has the vector facility installed. See the section "Vector-Operation Control" on page 2-6 for more information.

Priority of Vector Interruptions

Multiple program-interruption conditions for vector-facility instructions are recognized, one after another, according to the same priority rules as apply to other instructions, together with the following rules:

- The unnormalized-operand exception has the same priority with respect to the nonarithmetic exceptions as the other arithmetic exceptions which can occur for vector instructions (exponent overflow, exponent underflow, fixed-point overflow, floating-point divide, and significance).

When more than one arithmetic-exception condition is recognized at the same time, unnormalized operand takes precedence over the exponent-overflow and exponent-underflow exceptions; the floating-point-divide exception takes precedence over the unnormalized-operand exception.

- The vector-operation exception has the same priority as the operation

exception; the two exceptions are mutually exclusive.

- An access exception caused by the operand of RESTORE VSR takes precedence over a specification exception caused by the same operand.

See also the section "Multiple Program-Interruption Conditions" in Chapter 6, "Interruptions," of *IBM 370-XA Principles of Operation* and *IBM System/370 Principles of Operation*.

PROGRAM SWITCHING

The following instructions are provided to save, restore, and clear the vector-facility registers when switching from one program to another. The instructions marked "privileged" are restricted to programs operating in the supervisor state.

```
CLEAR VR
RESTORE VAC (privileged)
RESTORE VMR
RESTORE VR
RESTORE VSR
SAVE CHANGED VR (privileged)
SAVE VAC (privileged)
SAVE VMR
SAVE VR
SAVE VSR
```

Saving and restoring of the vector registers is further assisted by their associated vector in-use bits and vector change bits. When the vector in-use bit for a vector-register pair is zero, the saving and subsequent restoring of those registers are eliminated, thus reducing the program-switching time, because the registers are known to contain all zeros.

For programs operating in the supervisor state, the vector change bits may serve to reduce switching time still further by permitting the saving of a vector-register pair to be eliminated when its vector in-use bit is one but its vector change bit is zero. Although such a vector-register pair is in use, its contents are known not to have been changed if its vector change bit has remained zero since it was last restored from its save area; consequently, the previously saved information is still valid.

The vector change bits do not affect the restoring of vector registers and, therefore, do not help to reduce the restore time. When an interruption-handling portion of the control program restores previously saved registers, restoring the contents of a pair of vector registers is not considered a change. Hence, executing RESTORE VR in the supervisor state is defined not to alter the vector change bits. Executing RESTORE VR in the problem state, however, sets the vector change bit of the affected vector-register pair to one, so as to protect the integrity of its use by the control program.

Program Use of the Restore and Save Instructions

The instructions RESTORE VR, SAVE CHANGED VR, and SAVE VR are defined to be interruptible and to restore or save only a single pair of vector registers each time they are executed. When more than one vector-register pair is to be restored or saved, the appropriate instruction must be used in a programming loop as follows.

First, the even general register to be specified by the instruction should be set to the beginning of the save area for the vector registers, and the odd general register should be set to zeros. Then the restore or save instruction should be executed. It should be followed by a BRANCH ON CONDITION with a mask of 5 back to the restore or save instruction. This causes each vector-register pair, in turn, to be restored or saved if its vector in-use bit (or vector change bit for SAVE CHANGED VR) is one, or to be skipped if the bit is zero.

Restore Operations

To restore the vector-status register and the vector registers, the instruction RESTORE VSR should be executed before the above programming loop for RESTORE VR. A complete set of restore operations also includes RESTORE VMR and RESTORE VAC. RESTORE VAC should be the last restore instruction executed to avoid having the others advance the vector-activity count unnecessarily.

Save Operations

A complete set of save operations consists of the instruction SAVE VAC, followed by a loop that uses either SAVE VR or SAVE CHANGED VR, and then the instructions SAVE VMR and SAVE VSR.

SAVE VAC is executed first, so as to avoid having the vector-activity count advanced by the other save operations, especially at a time when no vector operations were performed since the last time that the registers were restored.

Programs running in either the problem state or the supervisor state may use the instruction SAVE VR in the loop to save the entire contents of all vector-register pairs for which the vector in-use bits are ones.

Alternatively, when a program using vector-facility instructions is interrupted and the vector registers are to be placed back into an area from which they were previously restored, an interruption handler in the supervisor state may use the privileged instruction SAVE CHANGED VR in the loop. SAVE VSR should be executed only after the vector registers have been saved, so that the vector change bits, which SAVE CHANGED VR sets to zeros, are saved as zeros.

SAVE VR should be used instead of SAVE CHANGED VR when the vector information is to be saved in an area which may not be the one from which the vector registers were last restored. Thus, SAVE VR is the appropriate instruction for a machine-check-interruption handler.

Clear Operations

The instruction CLEAR VR may be used to clear all or selected pairs of vector registers and to make sure that the vector interruption index is set to zero.

CLEAR VR may be executed by the control program to ensure that all vector registers are cleared before turning over the vector facility to a new program requesting vector operations. It should also be executed by the vector program to clear a vector-register pair that is not needed again soon. Both measures serve to avoid unnecessary saving and restoring.

When a vector-register pair has been cleared by means of CLEAR VR, and the corresponding vector in-use bit is zero, all elements in those registers contain zeros. The zero elements in a cleared register are valid operands. Such use of a cleared vector register or register pair as a source of all zeros does not set the associated vector in-use bit to one. One or more individual elements of a cleared vector-register pair may be replaced by an instruction such as LOAD ELEMENT, but as soon as any element in either or both registers of the pair has been changed, its vector in-use bit and vector change bit are set to ones, and the register pair is no longer considered cleared. The vector registers are considered to have been changed even when the value loaded is all zeros.

The instruction RESTORE VSR also clears a vector-register pair when it finds that the associated vector in-use bit is one and must be set to zero.

When either CLEAR VR or RESTORE VSR finds a vector in-use bit that is already zero, the instruction does not clear the vector-register pair again. If either instruction is interrupted and later reexecuted, instruction execution is resumed from the beginning, but the instruction skips over registers that were cleared before the interruption and have remained cleared.

Save-Area Requirements

To make programs that save and restore registers of the vector facility model-independent, the sizes and addresses of the save areas should be computed at execution time using the current section size, as obtained by the instruction STORE VECTOR PARAMETERS.

Figure 2-8 on page 2-30 shows the save-area sizes and the boundary alignment for RESTORE VR, SAVE CHANGED VR, and SAVE VR as a function of the section size. Boundary alignment requires that the address of a vector-register save area be a multiple of the integral boundary shown in the second column (8 times the section size). The save-area size is given as the number of bytes required to save all 16 vector registers; when fewer consecutive vector registers are to be saved, this area may be

reduced correspondingly. The figure also shows the vector-mask register (VMR), which requires $4Z$ bits ($Z/2$ bytes), where Z is the section size; the VMR save area has no alignment requirement.

Section Size (Z)	Vector Registers		Bytes for Vector-Mask Register ($Z/2$)
	Integral Boundary ($8Z$)	Bytes for 16 VRs ($64Z$)	
8	64	512	4
16	128	1,024	8
32	256	2,048	16
64	512	4,096	32
128	1,024	8,192	64
256	2,048	16,384	128
512	4,096	32,768	256

Figure 2-8. Save-Area Requirements

RELATIONSHIP TO OTHER FACILITIES

Program-Event Recording (PER)

The following PER events are recognized for instructions of the vector facility:

- Instruction fetching
- Storage alteration

Whether PER general-register-alteration events are recognized for vector-facility instructions is undefined.

When the net count is zero for IC- or IM-class instructions, when the vector count is zero for NC-class instructions, or when all active bits in the vector-mask registers are zeros for the STORE MATCHED instruction, no PER storage-alteration events are recognized.

When an interruptible vector instruction is interrupted and PER storage alteration applies to storage locations corresponding to vector elements that are due to be changed by the instruction beyond the point of interruption, PER storage alteration is indicated if any such storage change actually occurred and may be indicated even if such a change did not occur. PER storage alteration is only recognized if no access exception exists for such

locations at the time that the instruction is executed.

Vector-Store Operations

As for nonvector instructions, the processing of vector-facility instructions generally appears to a program running on the same CPU to follow the conceptual sequence: The execution of one instruction appears to precede the execution of the following instruction, the processing of one vector element appears to precede the processing of the following vector element, and an interruption takes place between instructions or between units of operation of interruptible instructions. As discussed below, however, this conceptual sequence is not necessarily observed by programs on other CPUs, by channel programs, or when vector-facility instructions are used to store into the instruction stream.

Storage-Operand Consistency

For all vector-facility instructions, multiple accesses may be made to all or some of the bytes of a storage operand.

Thus, unlike instructions which make only single-access references, intermediate results of a vector-facility store instruction may be observed by channel programs and by other CPU programs accessing the same storage location concurrently.

When an interruptible store-type vector instruction is interrupted and its execution is later resumed, a store performed by the instruction before its interruption may be repeated when execution is resumed.

(See the section "Storage-Operand Consistency" in Chapter 5, "Program Execution," of *IBM 370-XA Principles of Operation* and *IBM System/370 Principles of Operation*.)

Storing into Instruction Stream

When a vector-facility instruction is executed that causes storing into a location from which subsequent instructions have been prefetched, the copies of the prefetched instructions are not necessarily changed. (See the section

"Instruction Fetching" in Chapter 5, "Program Execution," of *IBM 370-XA Principles of Operation* and *IBM System/370 Principles of Operation* for a complete list of functions which cause all copies of prefetched instructions to be discarded.)

Resets

In regard to the operation of the vector facility, CPU reset terminates execution of the current vector instruction and any manual operation. Pending machine-check-interruption conditions affecting the vector facility and check-stop states are cleared. All copies of prefetched vector-facility instructions or operands are discarded.

Initial CPU reset initializes the vector-control bit, bit 14 of control register 0, to zero.

The registers of the vector facility (vector-status register, vector-mask register, vector-activity count, and all vector registers) are cleared to zero by clear reset and power-on reset. The section size and partial-sum number remain unaffected.

Machine-Check Handling

Two bits of the machine-check-interruption code are associated with the vector facility: vector-facility failure and vector-facility source. The vector-facility-failure bit indicates to the program that vector-facility instructions should no longer be used. The vector-facility-source bit is a modifier to instruction-processing damage, which indicates that the vector facility is the error source.

These bits may be set to ones regardless of whether the vector-control bit, bit 14 of control register 0, is one or zero.

Vector-Facility Failure

Bit 6 (VF) of the machine-check-interruption code, when one, indicates that the vector facility has failed to such an extent that the service processor has made the facility not available.

This bit is not meaningful when system damage, bit 0 of the machine-check-interruption code, is one.

Vector-facility failure is a repressible condition, which has no subclass mask.

Vector-Facility Source

Bit 13 (VS) of the machine-check-interruption code, when one, indicates that the vector facility is the source of the reported machine-check condition. Vector-facility source is reported together with instruction-processing damage. When this bit is one, the contents of vector-facility registers may have been damaged or may contain incorrect information with no preserved error.

This bit is not meaningful when vector-facility failure, bit 6, is one.

Validation of Vector-Facility Registers

The following procedure can be used to validate the registers associated with the vector facility. The program should first execute RESTORE VSR, specifying all vector in-use bits as ones. This validates the vector-status register by setting it without first inspecting the previous contents. The program should then execute RESTORE VAC, RESTORE VMR, and RESTORE VR to load and validate the vector-activity count, the vector-mask register, and the vector registers.

Programming Notes

1. When a vector-facility-failure condition is indicated, the program should stop using any functions associated with the vector facility. Thus, no vector-facility instructions should be executed; the vector-control bit, bit 14 of control register 0, should be set or remain set to zero; and the registers associated with the vector facility should not be validated or saved.
2. Although the purpose of the vector-facility-source bit is to indicate that the vector facility is the source of the instruction-processing

damage, it is possible in some situations that the bit may be set to one when failures have occurred both in the vector facility and in other parts of the CPU.

3. Since a vector-facility-source condition may imply that vector-facility registers have been damaged, the registers should be validated before further use is attempted. If the vector-control bit is zero, it must be set to one to perform the validation.
4. The instruction RESTORE VR is the only instruction which validates the vector registers, and then only if their vector in-use bits are ones.

In particular, the instruction CLEAR VR should not be used for validation, because this instruction may be implemented for performance reasons such that the registers are not actually cleared unless the program subsequently attempts to load or modify them. With this design, when the program next loads the vector register following a CLEAR VR instruction, only those elements which are not loaded, if any, are actually cleared at that time. Except for the possible effect on machine-check handling, this implementation gives the same results as if the instruction actually cleared the registers.

CHAPTER 3. VECTOR-FACILITY INSTRUCTIONS

Complete lists of vector-facility instructions and their mnemonics, formats, and operation codes are contained in Appendix B, "Lists of Instructions." The lists also indicate when the condition code is set and the exceptional conditions in operand designations, data, or results that cause a program interruption.

When, for a vector instruction, the operation on each element of the vector is the same as for a counterpart scalar instruction, the vector instruction description does not repeat these details. The complete definition in these cases can be obtained from the definition for the counterpart scalar instruction.

In many cases, several related vector operations are described under a single name. For example, MULTIPLY in the QST format is described as follows:

Mnemonic VR₁,QR₃,RS₂(RT₂) [QST]

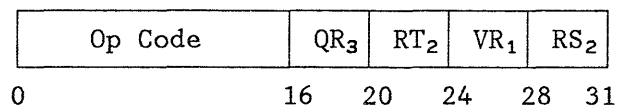

Mne- monic	Op Code	Operands
VMS	'A4A2'	Binary
VMDS	'A492'	Long
VMES	'A482'	Short multiplier and multiplicand, long product

This figure is a "shorthand" representation for three different instructions, one binary and two floating-point multiply instructions. It replaces the following set of three figures:

VMS VR₁,GR₃,RS₂(RT₂)
 [QST, Binary operands]

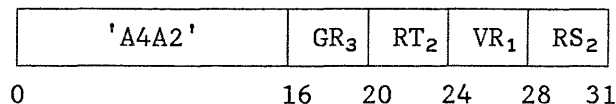

VMDS VR₁,FR₃,RS₂(RT₂)
 [QST, Long operands]

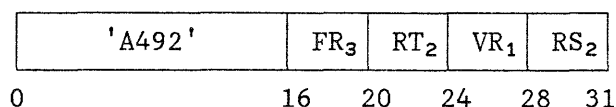

VMES VR₁,FR₃,RS₂(RT₂)
 [QST, Short multiplier and
 multiplicand, long product]

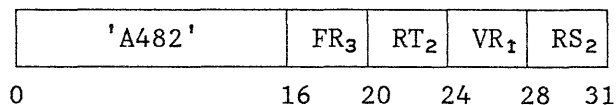

Thus, the term "Binary" under the heading "Operands" for the first instruction indicates that the vector elements are 32-bit signed binary integers, that the scalar operand is taken from a general register, and that the operation on each element pair is performed in the same manner as the scalar MULTIPLY instruction described in Chapter 7, "General Instructions," of *IBM 370-XA Principles of Operation* and *IBM System/370 Principles of Operation*.

Likewise, the terms "Short" or "Long" under the heading "Operands" for the second and third instructions indicate that the vector elements are floating-point numbers in the short or long floating-point format, respectively, that the scalar operand is taken from a floating-point register, and that the operation on each element pair is performed in the same manner as the corresponding scalar MULTIPLY instruction described in Chapter 9, "Floating-Point Instructions," of *IBM 370-XA Principles of Operation* and *IBM System/370 Principles of Operation*.

Except for the new suffixes Q and S, which indicate scalar-vector operations, each mnemonic for a vector instruction is generally the same as the mnemonic for the counterpart scalar instruction prefixed with a "V."

For several of the load and store instructions, the same instruction is used for vectors in the short floating-point format and in the 32-bit binary-integer or logical format. Separate mnemonics are assigned to the short and binary-logical formats for programming convenience, but the op codes for the two mnemonics are the same when the function is the same.

Programming Note

Programming notes in this section, as well as the examples in Appendix A, assume normal execution of vector instructions. In particular, they assume that the program does not alter the vector interruption index, so that each interruptible vector instruction begins its operation on the first element or element pair with the vector interruption index set to zero. If the instruction is interrupted for a cause other than an arithmetic exception, and if its execution is subsequently resumed, the vector interruption index and all other parameters are assumed to have been restored to the value they had at the time of interruption, so that the result is the same as if the interruption had not occurred.

ACCUMULATE

Mnemonic VR₁,RS₂(RT₂) [VST]

Op Code	////	RT ₂	VR ₁	RS ₂
0	16	20	24	28 31

Mnemonic	Op Code	Operands
VACD	'A417'	Long operand and sum
VACE	'A407'	Short operand, long sum

Mnemonic VR₁,VR₂ [VV]

Op Code	////////	VR ₁	VR ₂
0	16	24	28 31

Mnemonic	Op Code	Operands
VACDR	'A517'	Long operand and sum
VACER	'A507'	Short operand, long sum

Partial sums of the elements of the second-operand vector are accumulated by adding the second-operand elements to the contents of element positions 0 to *p*-1 of the first operand. The partial-sum number *p* depends on the model.

The operation proceeds in an ascending sequence of element numbers. The *I*-th element of the second operand is added to the first-operand element at a position which is the remainder of dividing *I* by *p*, where *I* varies from *X* to *C*-1, *X* is the initial vector interruption index (normally zero), and *C* is the vector count. The operation accumulates *C*-*X* elements of the second operand.

Thus, second-operand elements 0, *p*, 2*p*, ... are accumulated into position 0 of the first operand; second-operand elements 1, *p*+1, 2*p*+1, ... are accumulated into position 1; and so forth. The contents of first-operand element positions above *p*-1 remain unchanged.

Every addition is performed in the same manner as for the scalar ADD NORMALIZED (ADR) instruction, where the second-operand elements for VACE and VACER are extended on the right with 32 zeros, except that the condition code is not set.

A specification exception is recognized when the VR₁ field designates an invalid register number. In the VST format, a specification exception is also recognized when the second operand is not designated on an integral boundary, or when the RT₂ field is nonzero and designates the same general register as the RS₂ field.

ACCUMULATE is a class-IM instruction: it is interruptible, the vector count and vector interruption index determine the

number of elements processed, and its execution is under the control of the vector-mask mode.

Condition Code: The code remains unchanged.

Program Exceptions:

Access (fetch, operand 2 in VST format)
 Exponent overflow (with exception-extension code)
 Exponent underflow (with exception-extension code)
 Operation
 Significance (with exception-extension code)
 Specification
 Vector operation

Programming Notes

1. ACCUMULATE is used, together with ZERO PARTIAL SUMS and SUM PARTIAL SUMS, to produce the scalar sum of the elements of a vector in a manner similar to the example in Appendix A ("Sum of Products" on page A-3) of using MULTIPLY AND ACCUMULATE to produce a sum of products.
2. The short-format ACCUMULATE instructions (VACE and VACER) add floating-point vector elements in the short format to produce a floating-point sum in the long format. This creates a result of higher precision than would an equivalent loop with the scalar short-format ADD instructions (AE or AER, respectively), which produces a sum in the short format.

ADD

Mnemonic VR₁,QR₃,RS₂(RT₂) [QST]

Op Code	QR ₃	RT ₂	VR ₁	RS ₂
0	16	20	24	28 31

Mnemonic	Op Code	Operands
VAS	'A4A0'	Binary
VADS	'A490'	Long
VAES	'A480'	Short

Mnemonic VR₁,QR₃,VR₂ [QV]

Op Code	QR ₃	////	VR ₁	VR ₂
0	16	20	24	28 31

Mnemonic	Op Code	Operands
VAQ	'A5A0'	Binary
VADQ	'A590'	Long
VAEQ	'A580'	Short

Mnemonic VR₁,VR₃,RS₂(RT₂) [VST]

Op Code	VR ₃	RT ₂	VR ₁	RS ₂
0	16	20	24	28 31

Mnemonic	Op Code	Operands
VA	'A420'	Binary
VAD	'A410'	Long
VAE	'A400'	Short

Mnemonic VR₁,VR₃,VR₂ [VV]

Op Code	VR ₃	////	VR ₁	VR ₂
0	16	20	24	28 31

Mnemonic	Op Code	Operands
VAR	'A520'	Binary
VADR	'A510'	Long
VAER	'A500'	Short

Element by element, the second-operand vector is added to the third operand, and the result is placed in the first-operand location.

The operation is performed on each pair of elements in the same manner as the corresponding scalar operation, except that the condition code is not set. For floating-point operands, the scalar equivalent is ADD NORMALIZED.

A specification exception is recognized when a VR or QR field designates an

invalid register number. In the QST and VST formats, a specification exception is recognized when the second operand is not designated on an integral boundary, or when the RT_2 field is nonzero and designates the same general register as the RS_2 field. For the VAS instruction, a specification exception is also recognized when the QR_3 field designates the same general register as the RS_2 field.

ADD is a class-IM instruction: it is interruptible, the vector count and vector interruption index determine the number of elements processed, and its execution is under the control of the vector-mask mode.

Condition Code: The code remains unchanged.

Program Exceptions:

Access (fetch, operand 2 in QST and VST formats)

Exponent overflow (with exception-extension code; floating-point operands only)

Exponent underflow (with exception-extension code; floating-point operands only)

Fixed-point overflow (with exception-extension code; binary operands only)

Operation

Significance (with exception-extension code; floating-point operands only)

Specification

Vector operation

AND

VNS $VR_1, GR_3, RS_2(RT_2)$ [QST]

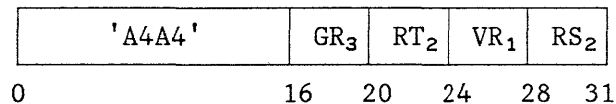

VNQ VR_1, GR_3, VR_2 [QV]

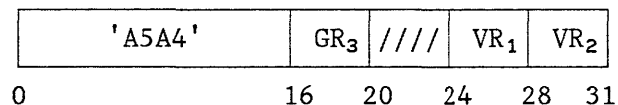

VN $VR_1, VR_3, RS_2(RT_2)$ [VST]

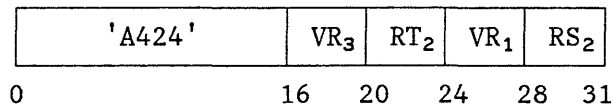

VNR VR_1, VR_3, VR_2 [VV]

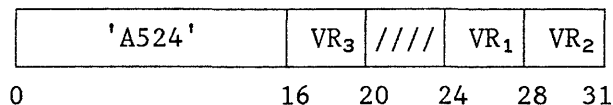

Element by element, the AND of the second and third operands is placed in the first-operand location.

The operation is performed on each pair of 32-bit elements in the same manner as the corresponding scalar operation, except that the condition code is not set.

For the VN and VNS instructions, a specification exception is recognized when the second operand is not designated on an integral boundary, or when the RT_2 field is nonzero and designates the same general register as the RS_2 field. For the VNS instruction, a specification exception is also recognized when the GR_3 field designates the same general register as the RS_2 field.

AND is a class-IM instruction: it is interruptible, the vector count and vector interruption index determine the number of elements processed, and its execution is under the control of the vector-mask mode.

Condition Code: The code remains unchanged.

Program Exceptions:

Access (fetch, operand 2 in QST and VST formats)

Operation

Specification

Vector operation

AND TO VMR

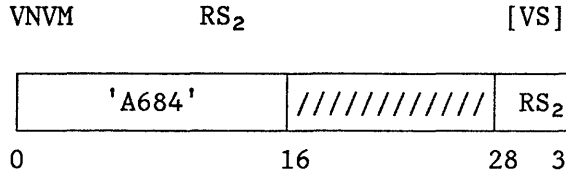

The AND of the second-operand bit vector and of the active bits of the vector-mask register is placed in the vector-mask register. Bits beyond the active bits are set to zeros.

AND TO VMR is a class-NC instruction: it is not interruptible, the vector count determines the number of elements processed, and its execution is not affected by the vector-mask mode.

Condition Code: The code remains unchanged.

Program Exceptions:

Access (fetch, operand 2)
Operation
Vector operation

CLEAR VR

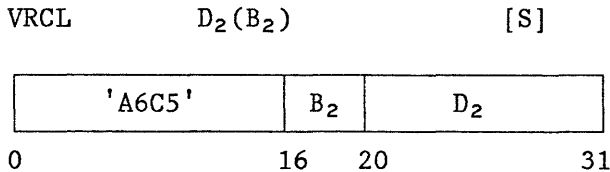

The specified pairs of vector registers are cleared, the associated vector in-use bits and vector change bits are set to zeros, and the vector interruption index is set to zero.

The second-operand address is not used to address storage. Instead, bits 24-31 of the second-operand address, called the second-operand bits, control which vector registers are cleared. The eight second-operand bits are associated with the eight even-numbered vector-register pairs from 0 to 14, and with the corresponding vector in-use bits and vector

change bits. The leftmost bits of the address are ignored.

The vector interruption index is set to zero first, after which the eight second-operand bits are examined in any order. If a second-operand bit and the corresponding vector in-use bit are both ones, all element positions of the associated pair of vector registers are cleared to zeros; the corresponding vector in-use bits and vector change bits are then set to zeros. If a second-operand bit or the corresponding vector in-use bit is zero, the associated registers and bits remain unchanged.

The instruction is interruptible. If it is interrupted before the operation is completed, the instruction address in the current PSW identifies this instruction. If execution is resumed, then vector-register pairs, which were cleared and had their vector in-use bits and vector change bits set to zeros, are not cleared again, provided that their vector in-use bits are still zeros.

The vector count is not used by the instruction and remains unchanged.

CLEAR VR is a class-IZ instruction: it is interruptible, the section size determines the number of elements processed, and its execution is not affected by the vector-mask mode.

Condition Code: The code remains unchanged.

Program Exceptions:

Operation
Vector operation

Programming Notes

1. When a vector in-use bit is zero, execution time of CLEAR VR is saved because the corresponding vector-register pair is already cleared, and the instruction does not clear those registers again.
2. CLEAR VR with a zero operand (VRCL 0) merely sets the vector interruption index to zero.

COMPARE

Mnemonic $M_1, QR_3, RS_2(RT_2)$ [QST]

Op Code	QR ₃	RT ₂	M ₁	RS ₂
0	16	20	24	28 31

Mnemonic	Op Code	Operands
VCS	'A4A8'	Binary
VCDS	'A498'	Long
VCES	'A488'	Short

Mnemonic M_1, QR_3, VR_2 [QV]

Op Code	QR ₃	////	M ₁	VR ₂
0	16	20	24	28 31

Mnemonic	Op Code	Operands
VCQ	'A5A8'	Binary
VCDQ	'A598'	Long
VCEQ	'A588'	Short

Mnemonic $M_1, VR_3, RS_2(RT_2)$ [VST]

Op Code	VR ₃	RT ₂	M ₁	RS ₂
0	16	20	24	28 31

Mnemonic	Op Code	Operands
VC	'A428'	Binary
VCD	'A418'	Long
VCE	'A408'	Short

Mnemonic M_1, VR_3, VR_2 [VV]

Op Code	VR ₃	////	M ₁	VR ₂
0	16	20	24	28 31

Mnemonic	Op Code	Operands
VCR	'A528'	Binary
VCDR	'A518'	Long
VCER	'A508'	Short

The third operand is compared with the second-operand vector, element by element. The corresponding bit in the vector-mask register is set to one or zero, depending on the comparison result and on the value of a modifier in bits 24-26 of the instruction.

The comparison is algebraic and is performed on each element pair in the same manner as the corresponding scalar operation, except for the way in which the result is indicated. The condition code is not set; instead, a single result bit is set in the vector-mask register for each element pair. The value of the result bit is selected from one of the modifier bits according to the comparison of the third-operand element with the second-operand element, as follows:

Result of Comparison	Modifier Bit Whose Value Is Selected
Operands equal	M0 (bit 24)
Operand 3 low	M1 (bit 25)
Operand 3 high	M2 (bit 26)

Modifier bit M3, bit 27 of the instruction, is ignored.

Bits in the vector-mask register which do not correspond to elements being compared remain unchanged.

A specification exception is recognized when a VR or QR field designates an invalid register number. In the QST and VST formats, a specification exception is recognized when the second operand is not designated on an integral boundary, or when the RT₂ field is nonzero and

designates the same general register as the RS₂ field. For the VCS instruction, a specification exception is also recognized when the QR₃ field designates the same general register as the RS₂ field.

COMPARE is a class-IC instruction: it is interruptible, the vector count and vector interruption index determine the number of elements processed, and its execution is not affected by the vector-mask mode.

Condition Code: The code remains unchanged.

Program Exceptions:

Access (fetch, operand 2 in QST and VST formats)
 Operation
 Specification
 Vector operation

Programming Notes

1. To obtain ones in the resultant bit vector when a desired comparison condition is found for an element of operand 3, the modifier bits should be specified as follows:

Modifier Bits				Result Is One If Operand-3 Comparison Is
M0	M1	M2	M3	
0	0	0	-	— (always 0)
0	0	1	-	High
0	1	0	-	Low
0	1	1	-	Not equal
1	0	0	-	Equal
1	0	1	-	Not low
1	1	0	-	Not high
1	1	1	-	Any (always 1)

2. The modifier bits of the vector COMPARE instruction correspond to the condition codes of the scalar COMPARE instruction when an element of vector operand 3 is the same as the scalar operand 1 and the corresponding element of vector operand 2 is the same as the scalar operand 2.

Thus, the value of the leftmost three bits of the mask field of the BRANCH ON CONDITION instruction, which causes branching when used to test the condition code of the scalar COMPARE, is the same as the modifier value of the vector COMPARE instruction, which sets a vector-mask bit to one for the same comparison condition.

3. The comparison instructions are the only ones which both modify the vector-mask register and are interruptible. They do not change those bits in the vector-mask register which lie beyond the last bit processed. This contrasts with the non-interruptible instructions which load or perform logical operations on the vector-mask register; they set to zeros all bits which lie beyond the last bit processed.
4. Unlike the related arithmetic and logical vector instructions, the comparison instructions are not executed under control of the vector-mask mode.

COMPLEMENT VMR

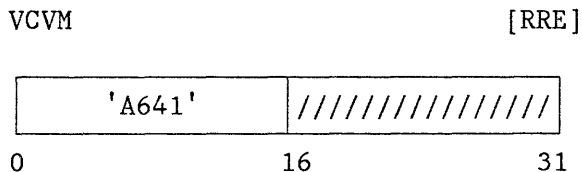

The active bits of the vector-mask register (VMR) are complemented. Bits beyond the active bits of the vector-mask register are set to zeros.

COMPLEMENT VMR is a class-NC instruction: it is not interruptible, the vector count determines the number of elements processed, and its execution is not affected by the vector-mask mode.

Condition Code: The code remains unchanged.

Program Exceptions:

Operation
 Vector operation

COUNT LEFT ZEROS IN VMR

VCZVM GR₁ [RRE]

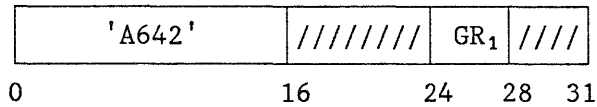

COUNT ONES IN VMR

VCOVM GR₁ [RRE]

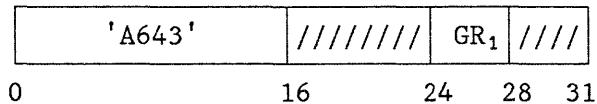

Selected bits among the active bits of the vector-mask register (VMR) are counted, and the count is added to the contents of the general register designated by GR₁. For the COUNT LEFT ZEROS IN VMR instruction, the selected bits are the zero bits to the left of the leftmost one bit. For the COUNT ONES IN VMR instruction, the selected bits are the one bits.

The general-register contents are treated as a 32-bit unsigned binary integer. Any carry out of the leftmost bit of the sum is ignored; there is no overflow indication.

Condition code 0, 1, or 3 is set according to whether the active bits are all zeros, mixed zeros and ones, or all ones. When the vector count is zero, the general register is not altered, and condition code 0 is set.

COUNT LEFT ZEROS IN VMR and COUNT ONES IN VMR are class-NC instructions: they are not interruptible, the vector count determines the number of elements processed, and their execution is not affected by the vector-mask mode.

Resulting Condition Code:

- 0 Active bits all zeros
- 1 Active bits mixed zeros and ones
- 2 --
- 3 Active bits all ones

Program Exceptions:

Operation
Vector operation

Programming Note

When only the condition-code result of COUNT LEFT ZEROS IN VMR or COUNT ONES IN VMR is required, but not the actual bit counts, the instruction TEST VMR may be used instead.

DIVIDE

Mnemonic VR₁,FR₃,RS₂(RT₂) [QST]

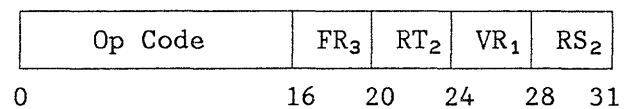

Mnemonic	Op Code	Operands
VDDS	'A493'	Long
VDES	'A483'	Short

Mnemonic VR₁,FR₃,VR₂ [QV]

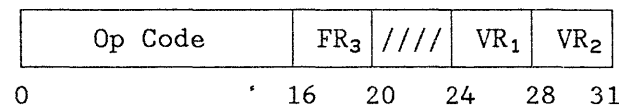

Mnemonic	Op Code	Operands
VDDQ	'A593'	Long
VDEQ	'A583'	Short

Mnemonic VR₁,VR₃,RS₂(RT₂) [VST]

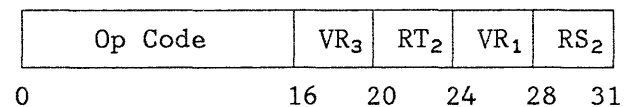

Mnemonic	Op Code	Operands
VDD	'A413'	Long
VDE	'A403'	Short

Mnemonic VR₁,VR₃,VR₂ [VV]

Op Code	VR ₃	////	VR ₁	VR ₂
0	16	20	24	28 31

Mnemonic	Op Code	Operands
VDDR	'A513'	Long
VDER	'A503'	Short

Element by element, the third operand is divided by the second-operand vector, and the result is placed in the first-operand location.

The operation is performed on each pair of elements in the same manner as the corresponding scalar operation, except for two changes. When the fraction part of a divisor element is zero, so that a floating-point-divide exception is recognized, the unit of operation is inhibited. Also, the operands are not first normalized; when one or both of the source-operand elements have a nonzero fraction with a leftmost hexadecimal digit of zero, an unnormalized-operand exception is recognized, and the unit of operation is inhibited.

The floating-point-divide exception takes precedence over the unnormalized-operand exception, and both take precedence over the exponent overflow and exponent underflow exceptions.

A specification exception is recognized when a VR or QR field designates an invalid register number. In the QST and VST formats, a specification exception is recognized when the second operand is not designated on an integral boundary, or when the RT₂ field is nonzero and designates the same general register as the RS₂ field.

DIVIDE is a class-IM instruction: it is interruptible, the vector count and vector interruption index determine the number of elements processed, and its execution is under the control of the vector-mask mode.

Condition Code: The code remains unchanged.

Program Exceptions:

- Access (fetch, operand 2 in QST and VST formats)
- Exponent overflow (with exception-extension code)
- Exponent underflow (with exception-extension code)
- Floating-point divide (with exception-extension code)
- Operation Specification
- Unnormalized operand (with exception-extension code)
- Vector operation

Programming Notes

1. The QST and QV formats provide for dividing a scalar operand by a vector. The operation of dividing a vector by a scalar can usually be replaced by the (generally faster) operation of multiplying the vector operand by the reciprocal of the scalar operand.
2. An unnormalized-operand exception is recognized whenever a divisor element is unnormalized, even if the corresponding dividend element is zero.

EXCLUSIVE OR

VXS VR₁,GR₃,RS₂(RT₂) [QST]

'A4A6'	GR ₃	RT ₂	VR ₁	RS ₂
0	16	20	24	28 31

VXQ VR₁,GR₃,VR₂ [QV]

'A5A6'	GR ₃	////	VR ₁	VR ₂
0	16	20	24	28 31

VX VR₁,VR₃,RS₂(RT₂) [VST]

'A426'	VR ₃	RT ₂	VR ₁	RS ₂
0	16	20	24	28 31

VXR VR₁,VR₃,VR₂ [VV]

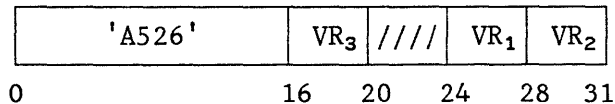

Element by element, the EXCLUSIVE OR of the second and third operands is placed in the first-operand location.

The operation is performed on each pair of 32-bit elements in the same manner as the corresponding scalar operation, except that the condition code is not set.

For the VX and VXS instructions, a specification exception is recognized when the second operand is not designated on an integral boundary, or when the RT₂ field is nonzero and designates the same general register as the RS₂ field. For the VXS instruction, a specification exception is also recognized when the GR₃ field designates the same general register as the RS₂ field.

EXCLUSIVE OR is a class-IM instruction: it is interruptible, the vector count and vector interruption index determine the number of elements processed, and its execution is under the control of the vector-mask mode.

Condition Code: The code remains unchanged.

Program Exceptions:

Access (fetch, operand 2 in QST and VST formats)

Operation

Specification

Vector operation

EXCLUSIVE OR TO VMR

VXVM RS₂ [VS]

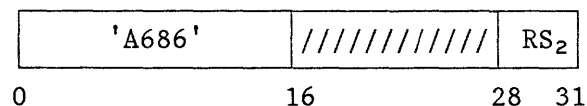

The EXCLUSIVE OR of the second-operand bit vector and of the active bits of the vector-mask register is placed in the

vector-mask register. Bits beyond the active bits are set to zeros.

EXCLUSIVE OR TO VMR is a class-NC instruction: it is not interruptible, the vector count determines the number of elements processed, and its execution is not affected by the vector-mask mode.

Condition Code: The code remains unchanged.

Program Exceptions:

Access (fetch, operand 2)

Operation

Vector operation

EXTRACT ELEMENT

Mnemonic VR₁,QR₃,GR₂ [VR]

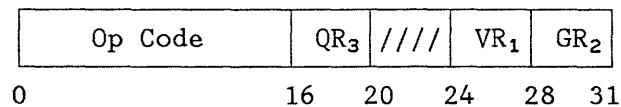

Mnemonic

Op Code

Operands

VXEL 'A629' Binary or logical

VXELD 'A619' Long

VXELE 'A609' Short

The element from the vector register or vector-register pair designated by VR₁, which has the element number contained in the general register designated by GR₂, is placed in the general or floating-point register designated by QR₃.

The element number is a 32-bit unsigned binary integer which must be less than the section size.

For VXELE, the rightmost 32 bits of the floating-point register designated by QR₃ remain unchanged.

For VXEL, if the GR₂ and QR₃ fields designate the same general register, the element number is obtained from that register before it is replaced by the specified vector element.

A specification exception is recognized when the VR₁ or QR₃ field designates an

invalid register number, or when the element number is equal to or greater than the section size.

EXTRACT ELEMENT is a class-N1 instruction: it is not interruptible, one element is processed, and its execution is not affected by the vector-mask mode. The vector count and vector interruption index are not used by the instruction and remain unchanged.

Condition Code: The code remains unchanged.

Program Exceptions:

Operation
Specification
Vector operation

EXTRACT VCT

VXVC GR₁ [RRE]

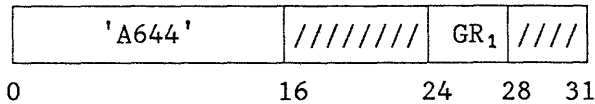

The vector count, with 16 zeros appended on the left, is placed in the general register designated by GR₁.

EXTRACT VCT is a class-N0 instruction: it is not interruptible, no elements are processed, and its execution is not affected by the vector-mask mode.

Condition Code: The code remains unchanged.

Program Exceptions:

Operation
Vector operation

EXTRACT VECTOR MASK MODE

VXVMM GR₁ [RRE]

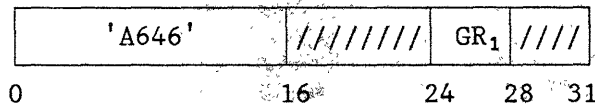

Bits 16-31 of the general register designated by GR₁ are set to the value of

bits 0-15 of the vector-status register. Thus, bit 31 of the general register indicates the current setting of the vector-mask mode. Bits 0-15 of the general register are set to zeros.

EXTRACT VECTOR MASK MODE is a class-N0 instruction: it is not interruptible, no elements are processed, and its execution is not affected by the vector-mask mode.

Condition Code: The code remains unchanged.

Program Exceptions:

Operation
Vector operation

Programming Note

The program should not rely on bits 16-30 of the general register being set to zeros. Those bits correspond to unassigned bits of the vector-status register, which are reserved for possible future use.

LOAD

Mnemonic VR₁,QR₂ [QV]

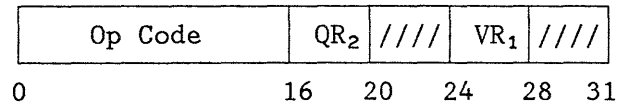

Mnemonic	Op Code	Operands
VLQ	'A5A9'	Binary or logical
VLDQ	'A599'	Long
VLEQ	'A589'	Short

Mnemonic VR₁,RS₂(RT₂) [VST]

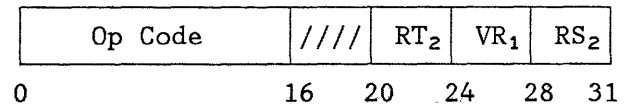

Mnemonic	Op Code	Operands
VL	'A409'	Binary or logical
VLD	'A419'	Long
VLE	'A409'	Short

Mnemonic VR₁,VR₂ [VV]

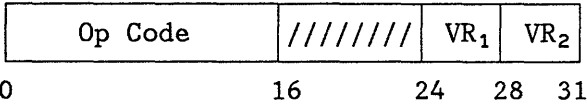

Mnemonic	Op Code	Operands
VLR	'A509'	Binary or logical
VLDR	'A519'	Long
VLER	'A509'	Short

Element by element, the second operand is placed unchanged in consecutive first-operand locations.

A specification exception is recognized when a VR or QR field designates an invalid register number. In the VST format, a specification exception is also recognized when the second operand is not designated on an integral boundary, or when the RT₂ field is nonzero and designates the same general register as the RS₂ field.

LOAD is a class-IC instruction: it is interruptible, the vector count and vector interruption index determine the number of elements processed, and its execution is not affected by the vector-mask mode.

Condition Code: The code remains unchanged.

Program Exceptions:

Access (fetch, operand 2 in VST format)
 Operation
 Specification
 Vector operation

LOAD BIT INDEX

VLBIX VR₁,GR₃,D₂(B₂) [RSE]

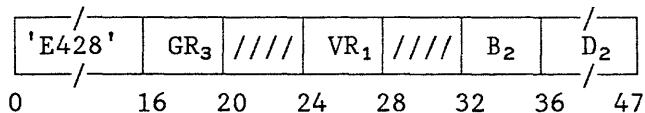

Bit by bit, the second operand is converted from a bit vector to a vector of element numbers, the result vector is placed in the first-operand location,

and the number of elements in the result vector is placed in the vector count.

The result-vector elements are 32-bit signed binary integers, which give the positions of the one bits in the second operand, relative to the starting address of the second operand and in sequence from left to right. No result-vector elements are generated for zero bits.

The GR₃ field must designate an even register number to specify an even-odd pair of general registers. The registers contain a bit index and a bit count, as follows:

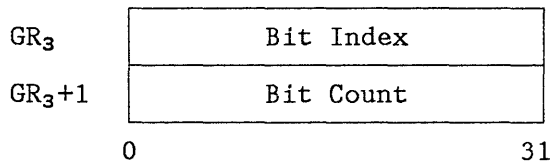

Both are treated as 32-bit signed binary integers. The bit index identifies the first bit of the second operand to be processed. The bit count gives the number of bits to be processed. If the bit count is zero or less than zero, no bits are processed. Upon completion or interruption of the instruction, the bit index identifies the next bit to be processed, and the bit count, if greater than zero, gives the number of bits remaining.

The address of the byte location containing the current bit to be processed is the sum, modulo the address size, of the second-operand address and of a number obtained by shifting bits 0-28 of the current bit index right by three bit positions, with bits equal to bit 0 being shifted into the leftmost three bit positions (without changing the contents of the general register). The rightmost three bits of the current bit index designate the bit within the byte.

Execution of the instruction consists of a repetition of the following procedure:

The current value of the vector interruption index is placed in the vector count. Then, if the vector count is equal to the section size, or if the bit count is zero or less than zero, the

vector interruption index is set to zero, and instruction execution is completed. Otherwise, the second-operand bit designated by the current bit index is selected. If the selected bit is one, the value of the bit index is placed in the first-operand element location designated by the vector interruption index, and the vector interruption index is then incremented by one. Next, regardless of the value of the selected bit, one is added algebraically to the bit index, and one is subtracted from the bit count. The procedure is then repeated.

Execution of the instruction may be interrupted, but only upon return to the starting point of the repetitive procedure.

When 31-bit addressing is in effect, incrementing the bit index beyond the value $2^{31}-1$ may cause an overflow, which is not signaled to the program. The result of incrementing the bit index beyond $2^{31}-1$ is undefined.

A specification exception is recognized when the GR_3 field designates an invalid register number.

The B_2 field should not designate the same general register as either of the pair of registers designated by the GR_3 field. The result fields (bit count, bit index, condition code, vector count, vector interruption index, and vector register) are undefined if B_2 is nonzero and $B_2 = GR_3$ or $B_2 = GR_3+1$.

LOAD BIT INDEX is a class-IG instruction: it is interruptible, a general register and the vector interruption index determine the number of elements processed, and its execution is not affected by the vector-mask mode.

Resulting Condition Code:

- 0 Vector count zero; bit count zero
- 1 Vector count zero; bit count less than zero
- 2 Vector count equal to section size; bit count greater than zero
- 3 Vector count greater than zero; bit count zero or less than zero

Program Exceptions:

Access (fetch, operand 2)
 Operation
 Specification
 Vector operation

Programming Notes

1. Example of LOAD BIT INDEX:

Bit Positions: 0 1 2 3 4 5 6 7 8

Bit Vector: 010001101

Result Vector: 1 5 6 8

2. The bit index in the even register should normally be set to zero by the program before entering a sectioning loop that contains the instruction. An initial nonzero value may be useful to shorten a bit vector that would otherwise contain a large number of leading zeros.
3. Assuming normal use of the instruction with the vector interruption index initially set to zero, LOAD BIT INDEX sets the vector count to the number of result elements generated. The vector count is then available to control subsequent vector instructions.

If condition code 2 is set, the vector count has been set to the section size; a full section of element numbers has been loaded by the instruction, and more bits remain to be processed. If condition code 3 is set, the vector count has been set to a value equal to or less than the section size; the last or only section of element numbers has been loaded, and no more bits remain to be processed. If condition code 0 or 1 is set, the vector count is zero, and there were no bits to be processed and no element numbers to be loaded.

4. If all bits in the second operand are zeros, no result elements are generated, and the vector count is set to the initial vector interruption index, which normally is zero. This may also occur for the last pass through a sectioning loop using this instruction, if the number of one bits in the second

operand happens to be a multiple of the section size, thus generating one or more full sections, with the remainder of the second operand containing only zero bits. Subsequent vector instructions will still function correctly, because no elements are processed when the vector count is zero.

5. The effect on the result fields of specifying the same general register for the base register of the second operand and for the bit index or bit count is unpredictable; it may depend on the model, on the occurrence of asynchronous interruptions such as I/O, or on other events that are not under the direct control of the program.

6. Programs using extremely large values of the bit index when 31-bit addressing is in effect must limit those values so that they cannot exceed $2^{31}-1$, which corresponds to a byte location of $2^{28}-1$ relative to the second-operand address. Allowing the instruction to increment the bit index to the next value may or may not cause overflow; the next byte location might be either 2^{28} or -2^{28} relative to the second-operand address. The result may not be repeatable from one instruction execution to the next.

When 24-bit addressing is in effect, byte addresses in storage are computed modulo 2^{24} , so that the possibility of overflow at a bit index of $2^{31}-1$ does not affect the resultant address.

7. Figure 3-1 is a summary of the operation.

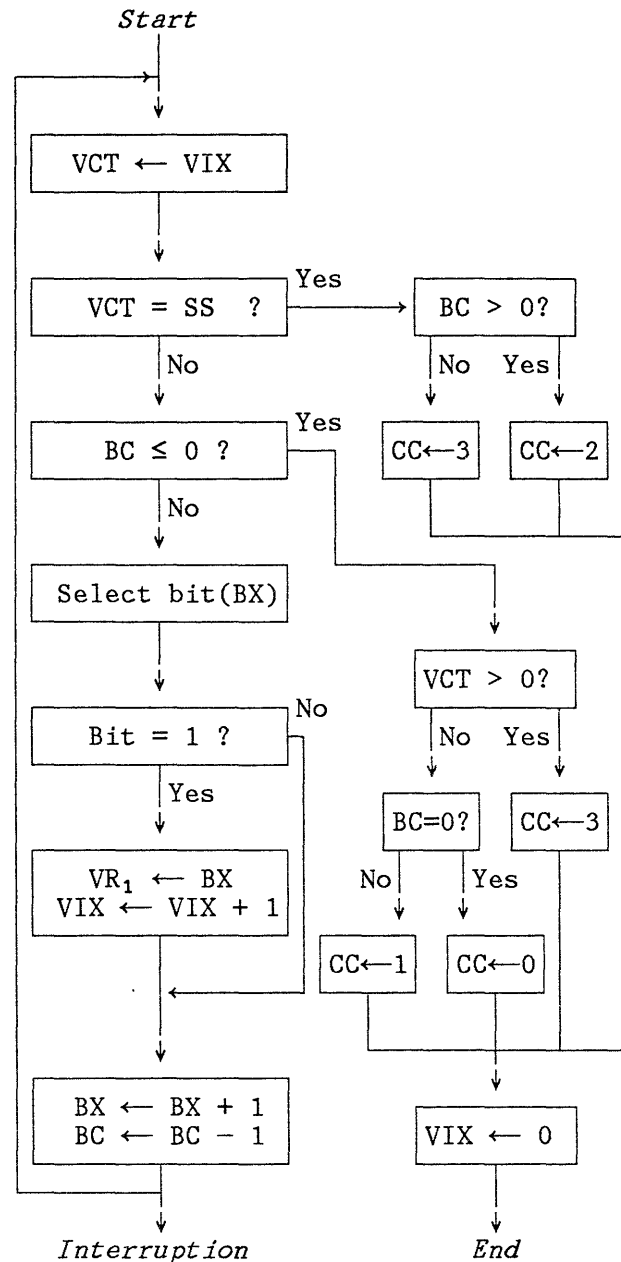

BC: Bit count in GR₃+1
 BX: Bit index in GR₃
 CC: Condition code
 SS: Section size
 VCT: Vector count
 VIX: Vector interruption index

Figure 3-1. Execution of LOAD BIT INDEX

LOAD COMPLEMENT

Mnemonic VR₁,VR₂ [VV]

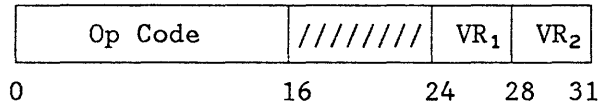

Mne- monic	Op Code	Operands
VLCR	'A562'	Binary
VLCDR	'A552'	Long
VLCER	'A542'	Short

Element by element, the second-operand vector is placed in the first-operand location with the opposite sign. For VLCR, each result element is the two's complement of the corresponding source element. For VLCDR and VLCER, each result element is the corresponding source element with the sign bit inverted.

The operation is performed on each element in the same manner as the corresponding scalar operation, except that the condition code is not set.

A specification exception is recognized when a VR field designates an invalid register number.

LOAD COMPLEMENT is a class-IM instruction: it is interruptible, the vector count and vector interruption index determine the number of elements processed, and its execution is under the control of the vector-mask mode.

Condition Code: The code remains unchanged.

Program Exceptions:

Fixed-point overflow (with exception-extension code; VLCR only)

Operation
Specification
Vector operation

LOAD ELEMENT

Mnemonic VR₁,QR₃,GR₂ [VR]

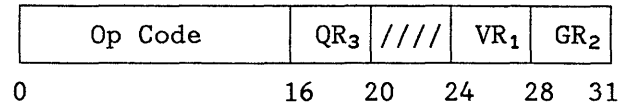

Mne- monic	Op Code	Operands
VLEL	'A628'	Binary or logical
VLELD	'A618'	Long
VLELE	'A608'	Short

The element in the vector register or vector-register pair designated by VR₁, which has the element number contained in the general register designated by GR₂, is replaced by the scalar operand in the general or floating-point register designated by QR₃.

The element number is a 32-bit unsigned binary integer which must be less than the section size.

A specification exception is recognized when the VR₁ or QR₃ field designates an invalid register number, or when the element number is equal to or greater than the section size.

LOAD ELEMENT is a class-N1 instruction: it is not interruptible, one element is processed, and its execution is not affected by the vector-mask mode. The vector count and vector interruption index are not used and remain unchanged.

Condition Code: The code remains unchanged.

Program Exceptions:

Operation
Specification
Vector operation

LOAD EXPANDED

Mnemonic $VR_1, RS_2(RT_2)$ [VST]

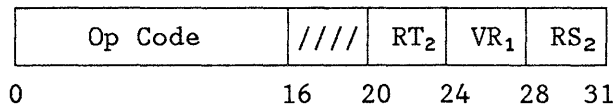

Mnemonic	Op Code	Operands
VLY	'A40B'	Binary or logical
VLYD	'A41B'	Long
VLYE	'A40B'	Short

Element by element, successive elements of the second-operand vector are placed unchanged in the element locations of the first operand that correspond to ones in the active bits of the vector-mask register. Element locations of the first operand that correspond to zeros in the active bits of the vector-mask register remain unchanged, and there are no corresponding second-operand locations in storage.

A specification exception is recognized when the VR_1 field designates an invalid register number, when the second operand is not designated on an integral boundary, or when the RT_2 field is nonzero and designates the same general register as the RS_2 field.

When the active bits of the vector-mask register are all zeros, no access exceptions are recognized for the storage location specified by the second operand.

LOAD EXPANDED is a class-IC instruction: it is interruptible, the vector count and vector interruption index determine the number of elements processed, and its execution is not affected by the vector-mask mode.

Condition Code: The code remains unchanged.

Program Exceptions:

Access (fetch, operand 2)
Operation

Specification
Vector operation

Programming Notes

1. The number of vector elements which are loaded from storage and the amount by which the address in the general register designated by RS_2 is updated correspond to the number of ones among the active bits of the vector-mask register.
2. The operation performed by LOAD EXPANDED is the opposite of STORE COMPRESSED.

LOAD HALFWORD

VLH $VR_1, RS_2(RT_2)$ [VST]

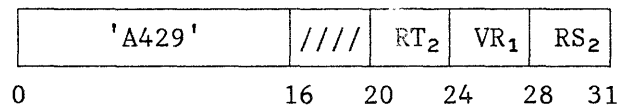

Element by element, the second operand is extended from a vector of 16-bit signed binary integers to a vector of 32-bit signed binary integers, and the result is placed in consecutive first-operand locations.

Each second-operand element is two bytes in length. The element is extended upon loading to 32 bits by setting each of the 16 leftmost bit positions of the first-operand element equal to the sign bit of the second-operand element.

A specification exception is recognized when the second operand is not designated on a halfword boundary, or when the RT_2 field is nonzero and designates the same general register as the RS_2 field.

LOAD HALFWORD is a class-IC instruction: it is interruptible, the vector count and vector interruption index determine the number of elements processed, and its execution is not affected by the vector-mask mode.

Condition Code: The code remains unchanged.

Program Exceptions:

Access (fetch, operand 2)
Operation
Specification
Vector operation

LOAD INDIRECT

Mnemonic VR₁,VR₃,D₂(B₂) [RSE]

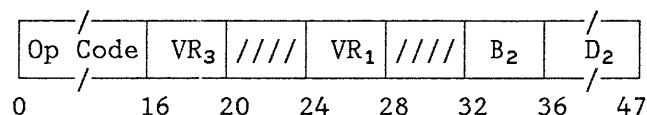

Mnemonic	Op Code	Operands
VLI	'E400'	Binary or logical
VLID	'E410'	Long
VLIE	'E400'	Short

Element by element, the third operand is used to select elements of the second-operand vector in storage and place them unchanged in the element positions of the first operand which correspond to those of the third operand.

The third operand is a vector of 32-bit signed binary integers. The address of each second-operand element is computed as the sum of the second-operand origin and the offset obtained from each element of the third operand, as follows.

The second-operand origin is generated from the base-address (B₂) and displacement (D₂) fields using the normal rules of address generation. The offset is obtained by shifting the current third-operand element to the left by two bits (for VLI or VLIE) or three bits (for VLID), with zeros appended on the right. The origin and offset are added. The rightmost 31 or 24 bits of the sum, depending on the address size, are used as the storage address. The second-operand element is fetched from that address and loaded into the first-operand location at the same element

position as that from which the third-operand element was obtained.

During the shift and addition operations, any carries or shifts into or out of the unused bit positions on the left are ignored.

A specification exception is recognized when the VR₁ field designates an invalid register number, or when the second operand is not designated on an integral boundary.

LOAD INDIRECT is a class-IC instruction: it is interruptible, the vector count and vector interruption index determine the number of elements processed, and its execution is not affected by the vector-mask mode.

Condition Code: The code remains unchanged.

Program Exceptions:

Access (fetch, operand 2)
Operation
Specification
Vector operation

Programming Note

LOAD INDIRECT is used to load a vector by indirect element selection. The instruction fetches elements from storage in the following sequence of addresses: $A + w \cdot VR_3(0)$, $A + w \cdot VR_3(1)$, $A + w \cdot VR_3(2)$, ..., where A is the origin of the vector in storage, w is the width of each element, and $VR_3(0)$, $VR_3(1)$, $VR_3(2)$, ... are the successive element numbers contained in the vector register designated by the VR₃ field of the instruction.

The origin is $A = (B_2) + D_2$, where (B₂) represents the contents of the base register designated by the B₂ field, and D₂ is the displacement designated by the D₂ field.

The element width w is 4 for VLI or VLIE and 8 for VLID. The storage elements are loaded successively into element positions VR₁(0), VR₁(1), VR₁(2), ... of the target register.

LOAD INTEGER VECTOR

VLINT VR₁,RS₂(RT₂) [VST]

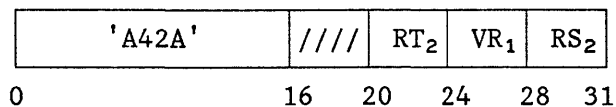

Element by element, a vector of uniformly spaced integers, as specified by the second-operand designation, is placed in consecutive first-operand locations.

If the vector interruption index X is less than the vector count, the contents of the general register designated by RS₂ replace element X of the first operand (normally X = 0 at the start). Then, the contents of that general register are incremented by adding the contents of the general register designated by RT₂ (the stride), both being treated as 32-bit binary integers. Any overflow during the addition is ignored. The vector interruption index X is then incremented by one.

These steps are repeated for each successive first-operand element until incrementing X causes it to equal the vector count. The vector interruption index is then set to zero.

The general register designated by RT₂ remains unchanged. If the RT₂ field of the instruction is zero, general register 0 is not used for the increment; instead, the increment is +1, so that consecutive integers are loaded.

A specification exception is recognized when the RT₂ field is nonzero and designates the same general register as the RS₂ field.

LOAD INTEGER VECTOR is a class-IC instruction: it is interruptible, the vector count and vector interruption index determine the number of elements processed, and its execution is not affected by the vector-mask mode.

Condition Code: The code remains unchanged.

Program Exceptions:

Operation
Specification
Vector operation

Programming Note

The operation resembles the generation of storage addresses for QST- and VST-format instructions, except that the element size is w = 1, no storage references for operands take place, no access exceptions for operands are recognized, and all 32 bits of both general registers participate in the operation. The result is independent of the address size.

Performing a LOAD INTEGER VECTOR operation also resembles the execution of a loop using the nonvector instruction LOAD ADDRESS. They differ in that LOAD INTEGER VECTOR does not depend on the address size; it does not set to zeros the leftmost one or eight bit positions. LOAD INTEGER VECTOR can generate negative numbers, which LOAD ADDRESS cannot.

LOAD MATCHED

Mnemonic VR₁,QR₂ [QV]

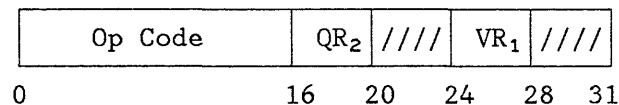

Mnemonic	Op Code	Operands
VLMQ	'A5AA'	Binary or logical
VLMDQ	'A59A'	Long
VLMEQ	'A58A'	Short

Mnemonic VR₁,RS₂(RT₂) [VST]

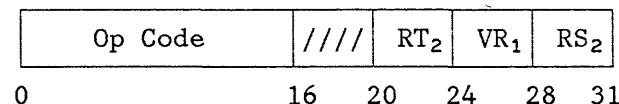

Mnemonic	Op Code	Operands
VLM	'A40A'	Binary or logical
VLMD	'A41A'	Long
VLME	'A40A'	Short

Mnemonic VR₁,VR₂ [VV]

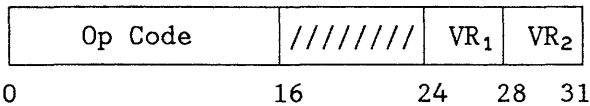

Mnemonic	Op Code	Operands
VLMR	'A50A'	Binary or logical
VLMDR	'A51A'	Long
VLMER	'A50A'	Short

Element by element, elements of the second operand corresponding to ones in the active bits of the vector-mask register are placed unchanged in the corresponding element locations of the first operand. Elements of the second operand corresponding to zeros in the active bits of the vector-mask register are not loaded, and the corresponding element locations of the first operand remain unchanged.

A specification exception is recognized when a VR or QR field designates an invalid register number. In the VST format, a specification exception is also recognized when the second operand is not designated on an integral boundary, or when the RT₂ field is nonzero and designates the same general register as the RS₂ field.

No access exceptions are recognized for elements of the second operand which correspond to zeros in the active bits of the vector-mask register; however, the general register designated by the RS₂ field is updated for each of those elements.

LOAD MATCHED is a class-IC instruction: it is interruptible, the vector count and vector interruption index determine the number of elements processed, and its execution is not affected by the vector-mask mode.

Condition Code: The code remains unchanged.

Program Exceptions:

Access (fetch, operand 2 in VST format)
Operation
Specification

Vector operation

Programming Notes

1. LOAD MATCHED functions the same as LOAD for those elements which correspond to ones in the active bits of the vector-mask register: each such element is loaded from the same storage location into the same vector-register position. It differs in that elements in storage corresponding to zeros in the active bits of the vector-mask register are skipped.
2. LOAD, LOAD EXPANDED, and LOAD MATCHED function the same, for corresponding formats, when all active bit positions of the vector-mask register contain ones.

LOAD NEGATIVE

Mnemonic VR₁,VR₂ [VV]

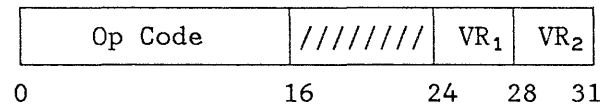

Mnemonic	Op Code	Operands
VLNR	'A561'	Binary
VLNDR	'A551'	Long
VLNER	'A541'	Short

Element by element, the negative of the absolute value of the second-operand vector is placed in the first-operand location.

The operation is performed on each element in the same manner as the corresponding scalar operation, except that the condition code is not set.

A specification exception is recognized when a VR field designates an invalid register number.

LOAD NEGATIVE is a class-IM instruction: it is interruptible, the vector count and vector interruption index determine the number of elements processed, and its execution is under the control of the vector-mask mode.

Condition Code: The code remains unchanged.

Program Exceptions:

Operation
Specification
Vector operation

LOAD POSITIVE

Mnemonic VR₁,VR₂ [VV]

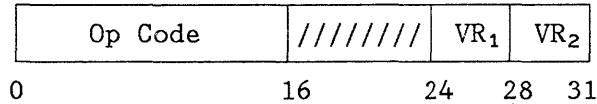

Mne- monic	Op Code	Operands
VLPR	'A560'	Binary
VLPDR	'A550'	Long
VLPER	'A540'	Short

Element by element, the absolute value of the second-operand vector is placed in the first-operand location.

The operation is performed on each element in the same manner as the corresponding scalar operation, except that the condition code is not set.

A specification exception is recognized when a VR field designates an invalid register number.

LOAD POSITIVE is a class-IM instruction: it is interruptible, the vector count and vector interruption index determine the number of elements processed, and its execution is under the control of the vector-mask mode.

Condition Code: The code remains unchanged.

Program Exceptions:

Fixed-point overflow (with exception-extension code; binary operand only)

Operation
Specification
Vector operation

LOAD VCT AND UPDATE

VLVCU GR₁ [RRE]

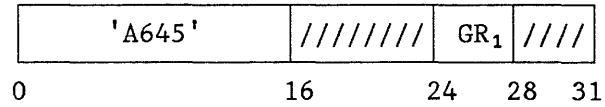

If the operand in the general register designated by the GR₁ field is greater than zero, the vector count (VCT) is replaced by the lesser of the section size and the operand. If the operand is zero or less than zero, the vector count is set to zero. The general register is then updated by subtracting the new vector count from the register contents.

The register contents are treated as a 32-bit signed binary integer. The vector count and section size are treated as 16-bit unsigned binary integers.

LOAD VCT AND UPDATE is a class-NO instruction: it is not interruptible, no elements are processed, and its execution is not affected by the vector-mask mode.

Resulting Condition Code:

- 0 Vector count zero; register result zero
- 1 Vector count zero; register result less than zero
- 2 Vector count equal to section size; register result greater than zero
- 3 Vector count greater than zero; register result zero

Program Exceptions:

Operation
Vector operation

Programming Notes

1. LOAD VCT AND UPDATE may be used at the start of a sectioning loop to determine the number of vector elements to be processed during each pass through the loop. Before entering the loop, the program initializes the general-register operand to the total number of elements in the vector. The end of the loop may simply be a BRANCH ON CONDITION instruction, if the condition

code has not been changed since the start of the loop, or the branch may be preceded by LOAD AND TEST specifying the general register as both the first and second operand.

If LOAD VCT AND UPDATE sets condition code 2, the vector count has been set to the section size; a full section of vector elements are to be processed, and more remain to be processed. If it sets condition code 3, the vector count has a value equal to or less than the section size, and the last or only section is to be processed. If it sets condition code 0 or 1, the vector count is zero, and there are no vector elements to be processed.

2. If LOAD AND TEST is used instead at the end of the loop, condition code 2 simply indicates that the general register contents are greater than zero, and there are more elements to be processed. Any other condition code means that there are no more elements.
3. The general-register operand remains greater than zero at the end of instruction execution only if condition code 2 is set. For the other condition codes, the final register contents are zero or negative.

LOAD VCT FROM ADDRESS

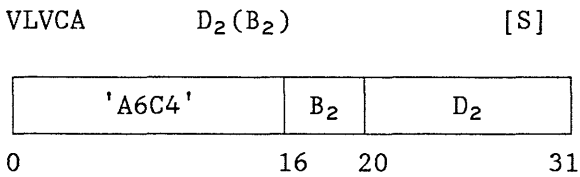

If the second-operand-address value is greater than zero, the vector count (VCT) is replaced by the lesser of the section size and the address value. If the second-operand-address value is zero or less than zero, the vector count is set to zero.

If the B_2 field of the instruction is not zero, the second-operand-address

value is formed by adding the contents of the general register designated by the B_2 field and the contents of the 12-bit D_2 field of the instruction. All 32 bits in the general register designated by the B_2 field participate in the addition, which is independent of the address size. The result of the addition is used as the operand itself and not to address storage. It is treated as a 32-bit signed binary integer.

If the B_2 field of the instruction is zero, general register 0 is not used; instead, the address value consists of the D_2 field with 20 zero bits appended on the left.

No storage references for operands take place, and the address value is not inspected for boundary alignment or access exceptions.

LOAD VCT FROM ADDRESS is a class-NO instruction: it is not interruptible, no elements are processed, and its execution is not affected by the vector-mask mode.

Resulting Condition Code:

- 0 Vector count zero; second-operand address zero
- 1 Vector count zero; second-operand address less than zero
- 2 Vector count equal to section size; second-operand address greater than section size
- 3 Vector count greater than zero; second-operand address less than or equal to section size and greater than zero

Program Exceptions:

Operation
Vector operation

Programming Note

LOAD VCT FROM ADDRESS may be used to set the vector count to the section size by specifying a B_2 field of zero and placing a value greater than 511 in the D_2 field.

LOAD VMR

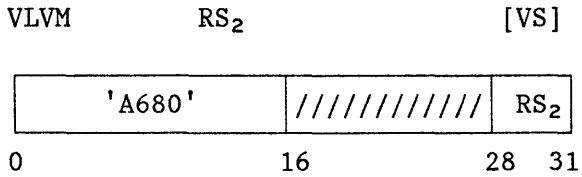

The second-operand bit vector replaces the active bits of the vector-mask register (VMR). Bits beyond the active bits are set to zeros.

LOAD VMR is a class-NC instruction: it is not interruptible, the vector count determines the number of elements processed, and its execution is not affected by the vector-mask mode.

Condition Code: The code remains unchanged.

Program Exceptions:

Access (fetch, operand 2)
Operation
Vector operation

LOAD VMR COMPLEMENT

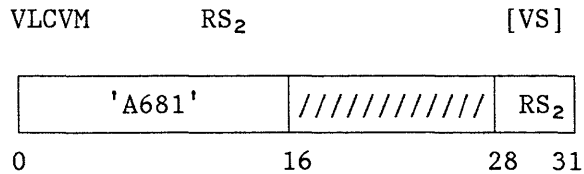

The complement of the bits from the second-operand bit vector replaces the active bits of the vector-mask register (VMR). Bits beyond the active bits are set to zeros.

LOAD VMR COMPLEMENT is a class-NC instruction: it is not interruptible, the vector count determines the number of elements processed, and its execution is not affected by the vector-mask mode.

Condition Code: The code remains unchanged.

Program Exceptions:

Access (fetch, operand 2)
Operation
Vector operation

LOAD ZERO

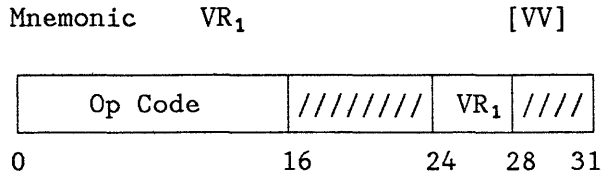

Mnemonic	Op Code	Operands
VLZR	'A50B'	Binary or logical
VLZDR	'A51B'	Long
VLZER	'A50B'	Short

The first-operand vector is cleared to zero. Only element positions numbered less than the vector count are set to zero. Any element positions numbered equal to or greater than the vector count remain unchanged.

A specification exception is recognized when the VR₁ field designates an invalid register number.

LOAD ZERO is a class-IC instruction: it is interruptible, the vector count and vector interruption index determine the number of element positions set to zero, and its execution is not affected by the vector-mask mode.

Condition Code: The code remains unchanged.

Program Exceptions:

Operation
Specification
Vector operation

Programming Note

The instruction LOAD ZERO is equivalent to LOAD (VLQ, VLDQ, or VLEQ) with an implied scalar source operand of zero. It provides the fastest way to set a vector register to zero.

MAXIMUM ABSOLUTE

Mnemonic VR_1, FR_3, GR_2 [VR]

Op Code	FR ₃	////	VR ₁	GR ₂
0	16	20	24	28 31

Mnemonic	Op Code	Operands
VMXAD	'A612'	Long
VMXAE	'A602'	Short

MAXIMUM SIGNED

Mnemonic VR_1, FR_3, GR_2 [VR]

Op Code	FR ₃	////	VR ₁	GR ₂
0	16	20	24	28 31

Mnemonic	Op Code	Operands
VMXSD	'A610'	Long
VMXSE	'A600'	Short

MINIMUM SIGNED

Mnemonic VR_1, FR_3, GR_2 [VR]

Op Code	FR ₃	////	VR ₁	GR ₂
0	16	20	24	28 31

Mnemonic	Op Code	Operands
VMNSD	'A611'	Long
VMNSE	'A601'	Short

The scalar third operand and all first-operand vector elements are compared to determine the maximum or minimum value, which replaces the third operand. The instruction MAXIMUM ABSOLUTE compares absolute values to select the maximum. The instructions MAXIMUM SIGNED and MINIMUM SIGNED compare signed values to select the maximum or minimum, respectively.

The comparison of each pair of absolute or signed operand values is performed in the same manner as the scalar floating-

point COMPARE instruction for the same format, except that the result is the selection of one element of the pair instead of a condition-code setting.

The scalar third operand is compared with each element of the first operand in turn to determine the selected (maximum absolute, maximum signed, or minimum signed) value. If the comparison is unequal and the first-operand element is the selected value, the first-operand element replaces the third operand; otherwise, no change takes place. The operation then continues with the next element of the first operand in the sequence of element numbers.

The GR₂ field must be zero or even. When nonzero, it designates an even-odd pair of general registers. The contents of the odd general register are treated as a 32-bit unsigned binary integer, which is incremented by one after each first-operand element has been processed; any carry out of bit position 0 is ignored. Each time a new selected value replaces the third operand, the current contents of the odd general register, before it is incremented, are placed in the even general register.

When the GR₂ field is zero, the action associated with the general registers is not performed, and their contents remain unchanged.

For VMXAE, VMXSE, and VMNSE, the right-most 32 bits of the floating-point register designated by FR₃ remain unchanged.

A specification exception is recognized when the VR₁, GR₂, or FR₃ field designates an invalid register number.

MAXIMUM ABSOLUTE, MAXIMUM SIGNED, and MINIMUM SIGNED are class-IM instructions: they are interruptible, the vector count and vector interruption index determine the number of elements processed, and its execution is under the control of the vector-mask mode. When the vector-mask mode is on, no selection takes place for first-operand elements corresponding to zero mask bits: the third operand and the even general register remain unchanged. However, when the GR₂ field is nonzero, the odd general register is incremented

by one for every first-operand element, regardless of the mode and mask bits.

Condition Code: The code remains unchanged.

Program Exceptions:

Operation
Specification
Vector operation

Programming Notes

1. Because the current third operand is compared with every element of the first operand, including element 0, these instructions can be used in a sectioning loop to find the selected value of a vector of any length. Before starting the first, or only, section, the program should initialize the third operand as follows.

MAXIMUM ABSOLUTE: zero
MAXIMUM SIGNED: largest negative value
MINIMUM SIGNED: largest positive value

2. If the GR₂ field is not zero, and the program initializes both of the specified pair of general registers to zero before executing the instruction, the even register will contain the number of the selected element, counting from the start (element 0) of the first section. If no element was selected, the even register will retain its initial contents. The odd register will contain the cumulative number of elements processed.

When the first operand contains two or more elements that could equally qualify as the selected element, the instruction selects the first one.

3. Since the element values are floating-point numbers, the rules for floating-point comparison apply, and two or more elements with different bit patterns may satisfy the test for maximum or minimum value. For example, elements with zero fractions compare equal even though their sign and characteristic may differ. (See also the programming

notes for the COMPARE instruction in Chapter 9, "Floating-Point Instructions," of *IBM 370-XA Principles of Operation* and *IBM System/370 Principles of Operation*.)

MULTIPLY

Mnemonic VR₁,QR₃,RS₂(RT₂) [QST]

Op Code	QR ₃	RT ₂	VR ₁	RS ₂
0	16	20	24	28 31

Mnemonic	Op Code	Operands
VMS	'A4A2'	Binary
VMDS	'A492'	Long
VMS	'A482'	Short multiplier and multiplicand, long product

Mnemonic VR₁,QR₃,VR₂ [QV]

Op Code	QR ₃	////	VR ₁	VR ₂
0	16	20	24	28 31

Mnemonic	Op Code	Operands
VMQ	'A5A2'	Binary
VMDQ	'A592'	Long
VMEQ	'A582'	Short multiplier and multiplicand, long product

Mnemonic VR₁,VR₃,RS₂(RT₂) [VST]

Op Code	VR ₃	RT ₂	VR ₁	RS ₂
0	16	20	24	28 31

Mnemonic	Op Code	Operands
VM	'A422'	Binary
VMD	'A412'	Long
VME	'A402'	Short multiplier and multiplicand, long product

Mnemonic VR₁,VR₃,VR₂ [VV]

Op Code	VR ₃	////	VR ₁	VR ₂
0	16	20	24	28 31

Mnemonic	Op Code	Operands
VMR	'A522'	Binary
VMDR	'A512'	Long
VMER	'A502'	Short multiplier and multiplicand, long product

Element by element, the product of the second operand and the third operand is placed in the first-operand location. The operation is performed on each pair of elements in the same manner as the corresponding scalar operation, except for the following differences:

1. For binary operands, the third-operand location is any vector register; each element of the third operand is a 32-bit signed binary integer, as is each element of the second operand. The first-operand location is a vector-register pair, which receives product elements consisting of 64-bit signed binary integers.
2. For floating-point operands, the operands are not first normalized. When one or both of the source-operand elements have a nonzero fraction with a leftmost hexadecimal digit of zero, an unnormalized-operand exception is recognized, and the unit of operation is inhibited.

A specification exception is recognized when a VR or QR field designates an invalid register number. In the QST and VST formats, a specification exception is recognized when the second operand is not designated on an integral boundary, or when the RT₂ field is nonzero and designates the same general register as the RS₂ field. For the VMS instruction, a specification exception is also recognized when the QR₃ field designates the same general register as the RS₂ field.

MULTIPLY is a class-IM instruction: it is interruptible, the vector count and vector interruption index determine the

number of elements processed, and its execution is under the control of the vector-mask mode.

Condition Code: The code remains unchanged.

Program Exceptions:

- Access (fetch, operand 2 in QST and VST formats)
- Exponent overflow (with exception-extension code; floating-point operands only)
- Exponent underflow (with exception-extension code; floating-point operands only)
- Operation Specification
- Unnormalized operand (with exception-extension code; floating-point operands only)
- Vector operation

MULTIPLY AND ACCUMULATE

Mnemonic VR₁,VR₃,RS₂(RT₂) [VST]

Op Code	VR ₃	RT ₂	VR ₁	RS ₂
0	16	20	24	28 31

Mnemonic	Op Code	Operands
VMCD	'A416'	Long
VMCE	'A406'	Short multiplier and multiplicand; long first operand, product, and sum

Mnemonic VR₁,VR₃,VR₂ [VV]

Op Code	VR ₃	////	VR ₁	VR ₂
0	16	20	24	28 31

Mnemonic	Op Code	Operands
VMCDR	'A516'	Long
VMCER	'A506'	Short multiplier and multiplicand; long first operand, product, and sum

Partial sums of the products of corresponding elements of the second and third operands are accumulated by adding the products to the contents of element positions 0 to $p-1$ of the first operand. The partial-sum number p depends on the model.

The operation proceeds in an ascending sequence of element numbers. The product of the I -th elements of the second and third operands is added to the first-operand element at a position which is the remainder of dividing I by p , where I varies from X to $C-1$, X is the initial vector interruption index (normally zero), and C is the vector count. The operation accumulates $C-X$ element products.

Thus, the products formed from second- and third-operand elements 0, p , $2p$, ... are accumulated into position 0 of the first operand; products from elements 1, $p+1$, $2p+1$, ... are accumulated into position 1; etc. The contents of first-operand element positions above $p-1$ remain unchanged.

Every multiplication is performed in the same manner as the corresponding scalar floating-point, short or long, MULTIPLY instruction, except that the operand elements are not first normalized. Every addition is performed in the same manner as the scalar instruction ADD NORMALIZED (ADR), except that the condition code is not set.

When one or both of a pair of second- and third-operand elements have a nonzero fraction with a leftmost hexadecimal digit of zero, an unnormalized-operand exception is recognized, and the unit of operation is inhibited.

If the multiplication of an element pair results in an exponent underflow, a true zero is used in place of the product in the addition operation, and no exception is recognized. If the multiplication results in an exponent overflow, the product replaces the corresponding partial-sum element, and an exponent overflow is recognized. Exceptions in the addition are recognized in the same

manner as for the scalar instruction ADD NORMALIZED (ADR).

A specification exception is recognized when a VR field designates an invalid register number. In the VST format, a specification exception is also recognized when the second operand is not designated on an integral boundary, or when the RT_2 field is nonzero and designates the same general register as the RS_2 field.

MULTIPLY AND ACCUMULATE is a class-IM instruction: it is interruptible, the vector count and vector interruption index determine the number of elements processed, and its execution is under the control of the vector-mask mode.

Condition Code: The code remains unchanged.

Program Exceptions:

- Access (fetch, operand 2 in VST format)
- Exponent overflow (with exception-extension code)
- Exponent underflow (with exception-extension code)
- Operation
- Significance (with exception-extension code)
- Specification
- Unnormalized operand (with exception-extension code)
- Vector operation

MULTIPLY AND ADD

Mnemonic $VR_1, FR_3, RS_2(RT_2)$ [QST]

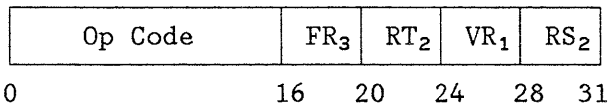

Mnemonic	Op Code	Operands
VMADS	'A494'	Long operands and sum
VMAES	'A484'	Short multiplier and multiplicand; long first operand, product, and sum

Mnemonic VR₁,FR₃,VR₂ [QV]

Op Code	FR ₃	////	VR ₁	VR ₂
0	16	20	24	28 31

Mnemonic	Op Code	Operands
VMADQ	'A594'	Long operands and sum
VMAEQ	'A584'	Short multiplier and multiplicand; long first operand, product, and sum

Mnemonic VR₁,FR₃,VR₂ [QV]

Op Code	FR ₃	////	VR ₁	VR ₂
0	16	20	24	28 31

Mnemonic	Op Code	Operands
VMSDQ	'A595'	Long operands and difference
VMSEQ	'A585'	Short multiplier and multiplicand; long first operand, product, and difference

Mnemonic VR₁,VR₃,RS₂(RT₂) [VST]

Op Code	VR ₃	RT ₂	VR ₁	RS ₂
0	16	20	24	28 31

Mnemonic	Op Code	Operands
VMAD	'A414'	Long operands and sum
VMAE	'A404'	Short multiplier and multiplicand; long first operand, product, and sum

Mnemonic VR₁,VR₃,RS₂(RT₂) [VST]

Op Code	VR ₃	RT ₂	VR ₁	RS ₂
0	16	20	24	28 31

Mnemonic	Op Code	Operands
VMSD	'A415'	Long operands and difference
VMSE	'A405'	Short multiplier and multiplicand; long first operand, product, and difference

MULTIPLY AND SUBTRACT

Mnemonic VR₁,FR₃,RS₂(RT₂) [QST]

Op Code	FR ₃	RT ₂	VR ₁	RS ₂
0	16	20	24	28 31

Mnemonic	Op Code	Operands
VMSDS	'A495'	Long operands and difference
VMSES	'A485'	Short multiplier and multiplicand; long first operand, product, and difference

Element by element, the third operand is multiplied by the second-operand vector, and the product is added to, or subtracted from, the first-operand vector. The sum or difference is placed in the first-operand location.

Every multiplication is performed in the same manner as the corresponding scalar floating-point, short or long, MULTIPLY instruction, except that the operand elements are not first normalized. Every addition or subtraction is performed in the same manner as the scalar instruction ADD NORMALIZED (ADR) or SUBTRACT NORMALIZED (SDR), respectively, except that the condition code is not set.

When one or both of a pair of second- and third-operand elements have a nonzero fraction with a leftmost hexadecimal digit of zero, an

unnormalized-operand exception is recognized, and the unit of operation is inhibited.

If the multiplication of an element pair results in an exponent underflow, a true zero is used in place of the product in the addition or subtraction operation, and no exception is recognized. If the multiplication of an element pair results in an exponent overflow, the corresponding product replaces the first-operand element, and an exponent overflow is recognized. Exceptions in the addition or subtraction are recognized in the same manner as for the scalar instruction ADD NORMALIZED (ADR) or SUBTRACT NORMALIZED (SDR), respectively.

A specification exception is recognized when a VR or FR field designates an invalid register number. In the QST and VST formats, a specification exception is also recognized when the second operand is not designated on an integral boundary, or when the RT₂ field is nonzero and designates the same general register as the RS₂ field.

MULTIPLY AND ADD and MULTIPLY AND SUBTRACT are class-IM instructions: they are interruptible, the vector count and vector interruption index determine the number of elements processed, and their execution is under the control of the vector-mask mode.

Condition Code: The code remains unchanged.

Program Exceptions:

- Access (fetch, operand 2 in QST and VST formats)
- Exponent overflow (with exception-extension code)
- Exponent underflow (with exception-extension code)
- Operation
- Significance (with exception-extension code)
- Specification
- Unnormalized operand (with exception-extension code)
- Vector operation

Programming Notes

1. The MULTIPLY AND ADD and MULTIPLY AND SUBTRACT operations may be summarized as:

$$op_1 = op_1 \pm op_3 * op_2$$

2. If the constant 1.0 is placed in the third-operand location, MULTIPLY AND ADD (VMAES or VMAEQ) and MULTIPLY AND SUBTRACT (VMSES or VMSEQ) may be used to add (subtract) a vector in the short format to (from) a vector in the long format.

OR

VOS VR₁, GR₃, RS₂ (RT₂) [QST]

	'A4A5'	GR ₃	RT ₂	VR ₁	RS ₂	
0		16	20	24	28	31

VOQ VR₁, GR₃, VR₂ [QV]

	'A5A5'	GR ₃	////	VR ₁	VR ₂	
0		16	20	24	28	31

VO VR₁, VR₃, RS₂ (RT₂) [VST]

	'A425'	VR ₃	RT ₂	VR ₁	RS ₂	
0		16	20	24	28	31

VOR VR₁, VR₃, VR₂ [VV]

	'A525'	VR ₃	////	VR ₁	VR ₂	
0		16	20	24	28	31

Element by element, the OR of the second and third operands is placed in the first-operand location.

The operation is performed on each pair of 32-bit elements in the same manner as the corresponding scalar operation,

except that the condition code is not set.

For the VO and VOS instructions, a specification exception is recognized when the second operand is not designated on an integral boundary, or when the RT₂ field is nonzero and designates the same general register as the RS₂ field. For the VOS instruction, a specification exception is also recognized when the GR₃ field designates the same general register as the RS₂ field.

OR is a class-IM instruction: it is interruptible, the vector count and vector interruption index determine the number of elements processed, and its execution is under the control of the vector-mask mode.

Condition Code: The code remains unchanged.

Program Exceptions:

Access (fetch, operand 2 in QST and VST formats)
 Operation
 Specification
 Vector operation

OR TO VMR

VOVM RS₂ [VS]

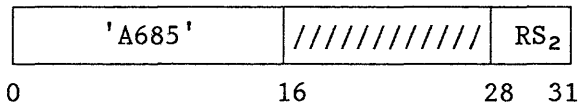

The OR of the second-operand bit vector and of the active bits of the vector-mask register is placed in the vector-mask register. Bits beyond the active bits are set to zeros.

OR TO VMR is a class-NC instruction: it is not interruptible, the vector count determines the number of elements processed, and its execution is not affected by the vector-mask mode.

Condition Code: The code remains unchanged.

Program Exceptions:

Access (fetch, operand 2)
 Operation
 Vector operation

RESTORE VAC

VACRS D₂(B₂) [S]

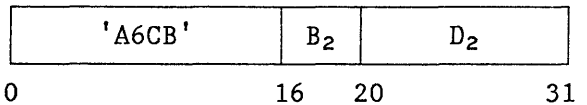

Bits 8-63 of the vector-activity count (VAC) are replaced by bits 8-63 of the doubleword designated by the second-operand address; bits 0-7 of the VAC are set to zeros. Execution of this instruction does not increment the vector-activity count and leaves the loaded value unchanged.

The operand must be designated on a doubleword boundary; otherwise, a specification exception is recognized.

RESTORE VAC is a class-NO instruction: it is not interruptible, no elements are processed, and its execution is not affected by the vector-mask mode.

Condition Code: The code remains unchanged.

Program Exceptions:

Access (fetch, operand 2)
 Operation
 Privileged operation
 Specification
 Vector operation

RESTORE VMR

VMRRS D₂(B₂) [S]

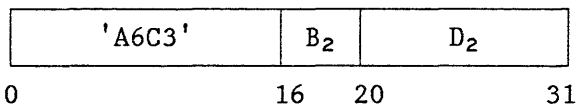

The second operand replaces the entire contents of the vector-mask register (VMR).

The length of the second operand is $4Z$ bits ($Z/2$ bytes), where Z is the section size. The contents of only the first Z bits are necessarily fetched and placed in the VMR; additional bits may or may not be fetched from the second operand, and access exceptions may or may not be recognized for that portion of the operand.

RESTORE VMR is a class-NZ instruction: it is not interruptible, the section size determines the number of elements processed, and its execution is not affected by the vector-mask mode. The vector count and vector interruption index are not used by the instruction and remain unchanged.

Condition Code: The code remains unchanged.

Program Exceptions:

Access (fetch, operand 2)
Operation
Vector operation

RESTORE VR

VRRS GR₁ [RRE]

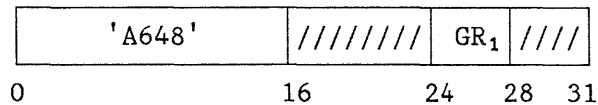

If the vector in-use bit associated with a specified pair of vector registers is one, the contents of those vector registers are replaced by consecutive doublewords from a storage area called the save area of the vector-register pair. If the vector in-use bit is zero, the vector registers remain unchanged. In either case, the address of the save area is incremented to the location of the save area of the next pair of vector registers.

The GR₁ field must designate an even register number to specify an even-odd pair of general registers. The even general register contains a save-area address, which specifies the storage location of the first element pair in the save area. The odd general register contains two unsigned binary integers: bits 0-15 of the register contain an element number, which designates the

location of the first element pair in the vector registers; bits 16-31 designate the vector-register (VR) pair.

Graphically, the general-register contents may be represented as follows:

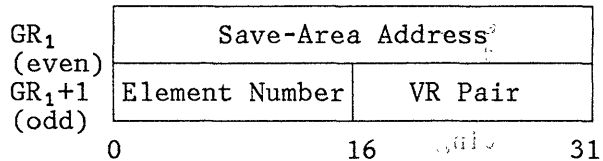

Depending on the address size, the rightmost 31 or 24 bits of the contents of the even general register are used as the save-area address. When the general register is updated to the address of the next location, the leftmost one or eight bit positions, respectively, of the general register are set to zeros.

The instruction is interruptible. When an interruption occurs, the save-area-address and element-number fields have been updated to indicate the next element to be processed in the current save area and vector registers.

At the completion of the instruction, the save-area-address field is updated to the storage location of the next pair of vector registers, the element-number field is set to zero, and the VR-pair field is incremented by 2. If vector-register pair 14 was just restored, the VR-pair field is set to 16, and the save-area-address field is set to the next address following the end of the save area of vector-register pair 14.

At the start of execution, the VR-pair field must be an even number from 0 to 14, and the element-number field must be less than the section size; also, whether or not the storage location will be accessed, the starting address of the save area for the current VR pair must be on a boundary which is a multiple of 8 times the section size.

The starting addresses of the save areas for the current and next pair of vector registers are given in the following formulas:

$$\begin{aligned} \text{SAC} &= \text{SAF} - 8 * \text{ENF} \\ \text{SAN} &= \text{SAC} + 8 * \text{SS} \end{aligned}$$

evaluated modulo the address size, where:

- ENF Contents of the element-number field at the beginning of the operation (normally zero)
- SAC Starting address of save area for the current VR pair
- SAF Contents of the save-area-address field at the beginning of the operation
- SAN Starting address of save area for the next VR pair
- SS Section size

If the vector in-use bit examined was associated with vector-register pair 14 and 15, condition code 0 or 2 is set according to whether the bit was zero or one, respectively. If the vector in-use bit examined was associated with any other register pair, condition code 1 or 3 is set according to whether the bit was zero or one, respectively.

When the CPU is in the problem state, and the vector in-use bit of the specified pair of vector registers is one, execution of this instruction sets the vector change bit of the vector-register pair to one; execution in the supervisor state does not alter the vector change bits.

A specification exception is recognized when at the start of execution:

- The GR₁ field designates an odd register number.
- The starting address of the save area is not a multiple of 8 times the section size.
- The element number is equal to or greater than the section size.
- The VR-pair field contains other than an even number from 0 to 14.

RESTORE VR is a class-IZ instruction: it is interruptible, the section size and element-number field determine the number of elements processed, and its execution is not affected by the vector-mask mode. The vector count and vector interruption index are not used and remain unchanged.

Resulting Condition Code:

- 0 VRs 14 and 15 examined and not restored
- 1 VR pair other than 14 and 15 examined and not restored
- 2 VRs 14 and 15 restored
- 3 VR pair other than 14 and 15 restored

Program Exceptions:

Access (fetch, save-area location)
Operation
Specification
Vector operation

Programming Note

See the section "Program Use of the Restore and Save Instructions" on page 2-28 for a discussion of the use of the instructions RESTORE VR, SAVE CHANGED VR, and SAVE VR.

RESTORE VSR

VSRRS D₂(B₂) [S]

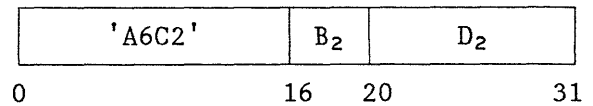

The contents of the vector-status register (VSR) are replaced by the doubleword designated by the second-operand address, and vector registers may be cleared depending on the vector in-use bits.

The vector in-use bits, bits 48-55 of the vector-status register, and the vector change bits, bits 56-63 of the register, are set in pairs sequentially from left to right, a vector in-use bit being set together with the corresponding vector change bit.

If the second operand specifies that a vector in-use bit is to be set to one, it is set to one. The setting of the corresponding vector change bit depends on whether the instruction is executed in the supervisor or problem state. If the vector in-use bit is set to one while in the supervisor state, the vector change bit is set to the value

specified by the second operand. If the vector in-use bit is set to one while in the problem state, the vector change bit is set to one, ignoring the second operand.

If the second operand specifies that a vector in-use bit is to be set to zero, the old setting of the vector in-use bit is first tested before it is changed. If the old setting was one, all element positions of the associated pair of vector registers are cleared to zeros, and both the vector in-use bit and the corresponding vector change bit are then set to zeros. If the old setting was zero, both the vector in-use bit and the corresponding vector change bit are simply set to zeros.

The instruction is interruptible. If it is interrupted before the operation is completed, the instruction address in the current PSW identifies this instruction. If the interrupted instruction is reissued, it is again executed from the beginning; vector-register pairs which were cleared and had their vector in-use bits and vector change bits set to zeros are not cleared again, provided that their vector in-use bits are still zeros.

A specification exception is recognized if any of the following is true:

- The second operand is not designated on a doubleword boundary.
- The value to be placed in bit positions 0-14 of the vector-status register is not all zeros.
- The value to be placed in the vector count, bits 16-31 of the vector-status register, is greater than the section size.
- The value to be placed in the vector interruption index, bits 32-47 of the vector-status register, is greater than the section size.

RESTORE VSR is a class-IZ instruction: it is interruptible, the section size determines the number of elements processed, and its execution is not affected by the vector-mask mode. The vector count and vector interruption index are loaded with values obtained from the second operand.

Condition Code: The code remains unchanged.

Program Exceptions:

Access (fetch, operand 2)
Operation
Specification
Vector operation

SAVE CHANGED VR

VRSVC GR₁ [RRE]

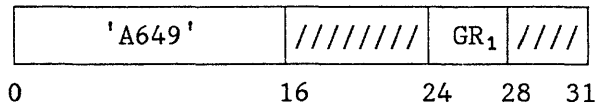

If the vector change bit associated with a specified pair of vector registers is one, the contents of those vector registers are placed in consecutive doublewords of a storage area called the save area of the vector-register pair, and the vector change bit is then set to zero. If the vector change bit is already zero, the vector registers are not stored. In either case, the address of the save area is incremented to the location of the save area of the next pair of vector registers.

If the vector change bit examined was associated with vector-register pair 14 and 15, condition code 0 or 2 is set according to whether the bit was zero or one, respectively. If the vector change bit examined was associated with any other register pair, condition code 1 or 3 is set according to whether the bit was zero or one, respectively.

The operand parameters and their updating are the same as for the instruction RESTORE VR.

A specification exception is recognized when at the start of execution:

- The GR₁ field designates an odd register number.
- The starting address of the save area is not a multiple of 8 times the section size.
- The element number is equal to or greater than the section size.

- The VR-pair field contains other than an even number from 0 to 14.

SAVE CHANGED VR is a class-IZ instruction: it is interruptible, the section size and element-number field determine the number of elements processed, and its execution is not affected by the vector-mask mode. The vector count and vector interruption index are not used and remain unchanged.

Resulting Condition Code:

- 0 VRs 14 and 15 examined and not saved
- 1 VR pair other than 14 and 15 examined and not saved
- 2 VRs 14 and 15 saved
- 3 VR pair other than 14 and 15 saved

Program Exceptions:

Access (store, save-area location)
 Operation
 Privileged operation
 Specification
 Vector operation

Programming Notes

1. The operation is the same as for SAVE VR, except that the instruction is privileged, the vector change bit takes the place of the vector in-use bit, and the vector change bit is set to zero after a vector-register pair is saved. The effect is that a vector-register pair is saved only if it has been loaded or modified since the last use of SAVE CHANGED VR designating this pair.

If the vector in-use bit is zero, the vector change bit is also zero, so that neither instruction will perform a save operation.

2. See the section "Program Use of the Restore and Save Instructions" on page 2-28 for a discussion of the use of the instructions RESTORE VR, SAVE CHANGED VR, and SAVE VR.

SAVE VAC

VACSV D₂(B₂) [S]

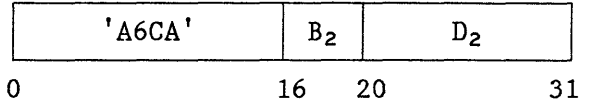

The current value of the vector-activity count (VAC) is stored at the doubleword designated by the second-operand address. Execution of this instruction does not increment the vector-activity count and leaves its value unchanged.

The operand must be designated on a doubleword boundary; otherwise, a specification exception is recognized.

SAVE VAC is a class-N0 instruction: it is not interruptible, no elements are processed, and its execution is not affected by the vector-mask mode.

Condition Code: The code remains unchanged.

Program Exceptions:

Access (store, operand 2)
 Operation
 Privileged operation
 Specification
 Vector operation

SAVE VMR

VMRSV D₂(B₂) [S]

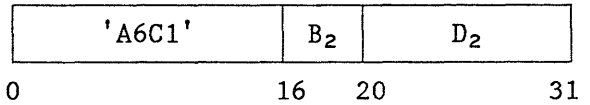

The contents of the entire vector-mask register (VMR) are placed unchanged in storage at the second-operand location.

The length of the second operand is 4Z bits (Z/2 bytes), where Z is the section size. Only the first Z bits of the result are defined to be the VMR contents; the remaining 3Z bits of the result are undefined, and storing of that part of the result may or may not take place.

SAVE VMR is a class-NZ instruction: it is not interruptible, the section size determines the number of elements processed, and its execution is not affected by the vector-mask mode. The vector count and vector interruption index are not used and remain unchanged.

Condition Code: The code remains unchanged.

Program Exceptions:

Access (store, operand 2)
Operation
Vector operation

SAVE VR

VRSV GR₁ [RRE]

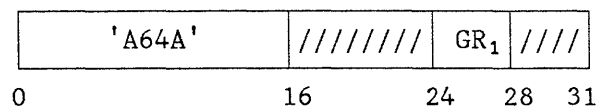

If the vector in-use bit associated with a specified pair of vector registers is one, the contents of those vector registers are placed in consecutive doublewords of a storage area called the save area of the vector-register pair. If the vector in-use bit is zero, the vector registers are not stored. In either case, the address of the save area is incremented to the location of the save area of the next pair of vector registers.

The operand parameters, their updating, and the condition-code setting are the same as for the instruction RESTORE VR.

A specification exception is recognized when at the start of execution:

- The GR₁ field designates an odd register number.
- The starting address of the save area is not a multiple of 8 times the section size.
- The element number is equal to or greater than the section size.
- The VR-pair field contains other than an even number from 0 to 14.

SAVE VR is a class-IZ instruction: it is interruptible, the section size and element-number field determine the number of elements processed, and its execution is not affected by the vector-mask mode. The vector count and vector interruption index are not used and remain unchanged.

Resulting Condition Code:

- 0 VRs 14 and 15 examined and not saved
- 1 VR pair other than 14 and 15 examined and not saved
- 2 VRs 14 and 15 saved
- 3 VR pair other than 14 and 15 saved

Program Exceptions:

Access (store, save-area location)
Operation
Specification
Vector operation

Programming Note

See the section "Program Use of the Restore and Save Instructions" on page 2-28 for a discussion of the use of the instructions RESTORE VR, SAVE CHANGED VR, and SAVE VR.

SAVE VSR

VRSRV D₂(B₂) [S]

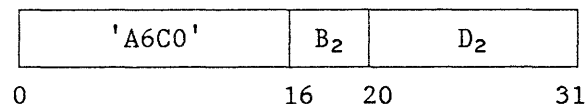

The contents of the vector-status register (VSR) are placed in storage at the doubleword location designated by the second-operand address, except that, when the CPU is in the problem state, the value of the vector change bits stored by the instruction is undefined.

A specification exception is recognized when the second operand is not designated on a doubleword boundary.

SAVE VSR is a class-NO instruction: it is not interruptible, no elements are processed, and its execution is not affected by the vector-mask mode.

Condition Code: The code remains unchanged.

Program Exceptions:

Access (store, operand 2)
 Operation
 Specification
 Vector operation

SET VECTOR MASK MODE

VSVM $D_2(B_2)$ [S]

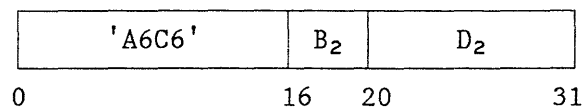

The vector-mask mode is set on or off, depending on whether the rightmost bit, bit 31, of the second-operand address is one or zero, respectively. The second-operand address is not used to address data, and all address bits other than bit 31 are ignored.

SET VECTOR MASK MODE is a class-NO instruction: it is not interruptible, no elements are processed, and its execution is not affected by the vector-mask mode.

Condition Code: The code remains unchanged.

Program Exceptions:

Operation
 Vector operation

SHIFT LEFT SINGLE LOGICAL

VSLL $VR_1, VR_3, D_2(B_2)$ [RSE]

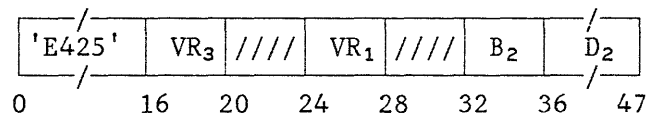

SHIFT RIGHT SINGLE LOGICAL

VSRL $VR_1, VR_3, D_2(B_2)$ [RSE]

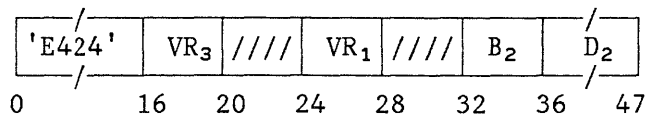

One by one, the elements in the third-operand vector are shifted left (VSLL) or right (VSRL) by the number of bits specified by the second-operand address, and the result is placed in the first-operand location.

The operation is performed on each element in the same manner as the corresponding scalar operation.

SHIFT LEFT SINGLE LOGICAL and SHIFT RIGHT SINGLE LOGICAL are class-IM instructions: they are interruptible, the vector count and vector interruption index determine the number of elements processed, and their execution is under the control of the vector-mask mode.

Condition Code: The code remains unchanged.

Program Exceptions:

Operation
 Vector operation

STORE

Mnemonic $VR_1, RS_2(RT_2)$ [VST]

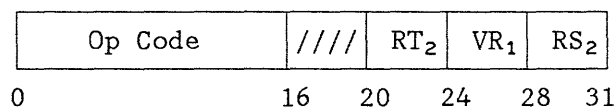

Mnemonic	Op Code	Operands
VST	'A40D'	Binary or logical
VSTD	'A41D'	Long
VSTE	'A40D'	Short

Element by element, the first-operand vector is placed unchanged in storage at the second-operand location.

A specification exception is recognized when the VR_1 field designates an invalid register number, when the second operand

is not designated on an integral boundary, or when the RT₂ field is nonzero and designates the same general register as the RS₂ field.

STORE is a class-IC instruction: it is interruptible, the vector count and vector interruption index determine the number of elements processed, and its execution is not affected by the vector-mask mode.

Condition Code: The code remains unchanged.

Program Exceptions:

Access (store, operand 2)
Operation
Specification
Vector operation

STORE COMPRESSED

Mnemonic VR₁,RS₂(RT₂) [VST]

Op Code	////	RT ₂	VR ₁	RS ₂
0	16	20	24	28 31

Mnemonic	Op Code	Operands
VSTK	'A40F'	Binary or logical
VSTKD	'A41F'	Long
VSTKE	'A40F'	Short

Element by element, elements of the first-operand vector corresponding to ones in the active bits of the vector-mask register are placed unchanged in storage at successive element locations of the second operand.

First-operand elements corresponding to zeros in the active bits of the vector-mask register are skipped, and there are no corresponding element locations of the second operand. If the active bits of the vector-mask register are all zeros, no access exceptions are recognized for the storage location specified by the second operand, the change bits for the storage operand remain unchanged, and no PER event for storage alteration is indicated.

A specification exception is recognized when the VR₁ field designates an invalid

register number, when the second operand is not designated on an integral boundary, or when the RT₂ field is nonzero and designates the same general register as the RS₂ field.

STORE COMPRESSED is a class-IC instruction: it is interruptible, the vector count and vector interruption index determine the number of elements processed, and its execution is not affected by the vector-mask mode.

Condition Code: The code remains unchanged.

Program Exceptions:

Access (store, operand 2)
Operation
Specification
Vector operation

Programming Notes

1. The number of vector elements which are stored and the amount by which the address in the general register designated by RS₂ is updated correspond to the number of ones among the active bits of the vector-mask register.
2. The operation performed by STORE COMPRESSED is the opposite of LOAD EXPANDED.

STORE HALFWORD

VSTH VR₁,RS₂(RT₂) [VST]

'A42D'	////	RT ₂	VR ₁	RS ₂
0	16	20	24	28 31

Element by element, the rightmost 16 bits of each first-operand vector element are placed unchanged in storage at the second-operand location.

A specification exception is recognized when the second operand is not designated on a halfword boundary, or when the RT₂ field is nonzero and designates the same general register as the RS₂ field.

STORE HALFWORD is a class-IC instruction: it is interruptible, the vector count and vector interruption index determine the number of elements processed, and its execution is not affected by the vector-mask mode.

Condition Code: The code remains unchanged.

Program Exceptions:

Access (store, operand 2)
Operation
Specification
Vector operation

STORE INDIRECT

Mnemonic VR₁,VR₃,D₂(B₂) [RSE]

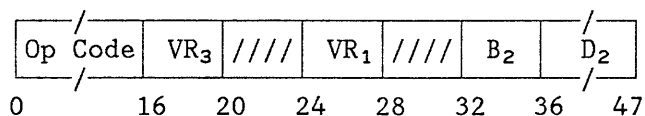

Mnemonic	Op Code	Operands
VSTI	'E401'	Binary or logical
VSTID	'E411'	Long
VSTIE	'E401'	Short

Element by element, the third operand is used to select element locations of the second operand in storage, at which elements of the first-operand vector are placed. The element positions of the first operand correspond to those of the third operand.

The method of selecting elements of the first, second, and third operands is the same as for LOAD INDIRECT, the amount of left shift of the third-operand elements being two bits for VSTI or VSTIE and three bits for VSTID. The selected first-operand elements are stored at the specified second-operand locations.

A specification exception is recognized when the VR₁ field designates an invalid register number, or when the second operand is not designated on an integral boundary.

STORE INDIRECT is a class-IC instruction: it is interruptible, the vector count and vector interruption index determine the number of elements proc-

essed, and its execution is not affected by the vector-mask mode.

Condition Code: The code remains unchanged.

Program Exceptions:

Access (store, operand 2)
Operation
Specification
Vector operation

Programming Note

STORE INDIRECT, which is the opposite of LOAD INDIRECT, is used to store a vector by indirect element selection. See also the programming note under LOAD INDIRECT.

STORE MATCHED

Mnemonic VR₁,RS₂(RT₂) [VST]

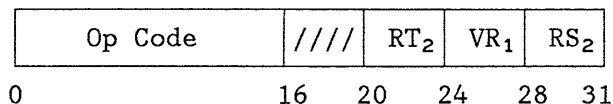

Mnemonic	Op Code	Operands
VSTM	'A40E'	Binary or logical
VSTMD	'A41E'	Long
VSTME	'A40E'	Short

Element by element, elements of the first-operand vector corresponding to ones in the active bits of the vector-mask register are placed unchanged in storage at the corresponding element locations of the second operand. Elements of the first operand corresponding to zeros in the active bits of the vector-mask register are not stored, and the corresponding second-operand locations in storage remain unchanged.

A specification exception is recognized when the VR₁ field designates an invalid register number, when the second operand is not designated on an integral boundary, or when the RT₂ field is nonzero and designates the same general register as the RS₂ field.

No access exceptions and PER storage-alteration events are recognized for

elements of the second operand which correspond to zeros in the active bits of the vector-mask register, and the corresponding change bits remain unchanged; however, the general register designated by the RS₂ field is updated for each of those elements.

STORE MATCHED is a class-IC instruction: it is interruptible, the vector count and vector interruption index determine the number of elements processed, and its execution is not affected by the vector-mask mode.

Condition Code: The code remains unchanged.

Program Exceptions:

Access (store, operand 2)
Operation
Specification
Vector operation

Programming Notes

1. STORE MATCHED functions the same as STORE for those elements which correspond to ones in the active bits of the vector-mask register: each such element is moved from the same vector-register position into the same storage location. It differs in that storage locations corresponding to zero bits remain unchanged.
2. STORE, STORE COMPRESSED, and STORE MATCHED function the same, for corresponding formats, when all active bit positions of the vector-mask register contain ones.

STORE VECTOR PARAMETERS

VSTVP D₂(B₂) [S]

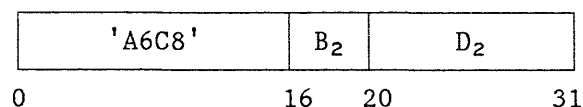

The 16-bit section size and the 16-bit partial-sum number are placed in storage in the left and right half, respec-

tively, of the word at the location designated by the second-operand address.

A specification exception is recognized when the second operand is not designated on a word boundary.

STORE VECTOR PARAMETERS is a class-N0 instruction: it is not interruptible, no elements are processed, and its execution is not affected by the vector-mask mode.

Condition Code: The code remains unchanged.

Program Exceptions:

Access (store, operand 2)
Operation
Specification
Vector operation

STORE VMR

VSTVM RS₂ [VS]

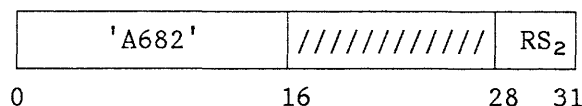

The contents of the active-bit positions of the vector-mask register are stored as a bit vector at the second-operand location.

When the vector count is not a multiple of 8, zeros are stored for any bits in the last byte which are to the right of the last bit specified by the vector count.

When the vector count is zero, no bits are stored. No access exceptions are recognized for the second operand, the change bits for the operand remain unchanged, and PER storage-alteration events are not indicated.

STORE VMR is a class-NC instruction: it is not interruptible, the vector count determines the number of elements processed, and its execution is not affected by the vector-mask mode.

Condition Code: The code remains unchanged.

Program Exceptions:

Access (store, operand 2)
 Operation
 Vector operation

SUBTRACT

Mnemonic $VR_1, QR_3, RS_2(RT_2)$ [QST]

Op Code	QR ₃	RT ₂	VR ₁	RS ₂
0	16	20	24	28 31

Mnemonic	Op Code	Operands
VSS	'A4A1'	Binary
VSDS	'A491'	Long
VSES	'A481'	Short

Mnemonic VR_1, QR_3, VR_2 [QV]

Op Code	QR ₃	////	VR ₁	VR ₂
0	16	20	24	28 31

Mnemonic	Op Code	Operands
VSQ	'A5A1'	Binary
VSDQ	'A591'	Long
VSEQ	'A581'	Short

Mnemonic $VR_1, VR_3, RS_2(RT_2)$ [VST]

Op Code	VR ₃	RT ₂	VR ₁	RS ₂
0	16	20	24	28 31

Mnemonic	Op Code	Operands
VS	'A421'	Binary
VSD	'A411'	Long
VSE	'A401'	Short

Mnemonic VR_1, VR_3, VR_2 [VV]

Op Code	VR ₃	////	VR ₁	VR ₂
0	16	20	24	28 31

Mnemonic	Op Code	Operands
VSR	'A521'	Binary
VSDR	'A511'	Long
VSER	'A501'	Short

Element by element, the second-operand vector is subtracted from the third operand, and the result is placed in the first-operand location.

The operation is performed on each pair of elements in the same manner as the corresponding scalar operation, except that the condition code is not set. For floating-point operands, the scalar equivalent is SUBTRACT NORMALIZED.

A specification exception is recognized when a VR or QR field designates an invalid register number. In the QST and VST formats, a specification exception is recognized when the second operand is not designated on an integral boundary, or when the RT₂ field is nonzero and designates the same general register as the RS₂ field. For the VSS instruction, a specification exception is also recognized when the QR₃ field designates the same general register as the RS₂ field.

SUBTRACT is a class-IM instruction: it is interruptible, the vector count and vector interruption index determine the number of elements processed, and its execution is under the control of the vector-mask mode.

Condition Code: The code remains unchanged.

Program Exceptions:

- Access (fetch, operand 2 in QST and VST formats)
- Exponent overflow (with exception-extension code; floating-point operands only)
- Exponent underflow (with exception-extension code; floating-point operands only)
- Fixed-point overflow (with exception-extension code; binary operands only)
- Operation
- Significance (with exception-extension code; floating-point operands only)
- Specification
- Vector operation

Programming Note

The QST and QV formats provide for subtracting a vector from a scalar operand. The operation of subtracting a scalar from a vector can be replaced by adding the negative of the scalar to the vector operand.

SUM PARTIAL SUMS

VSPSD VR₁,FR₂ [VR, Long Operands]

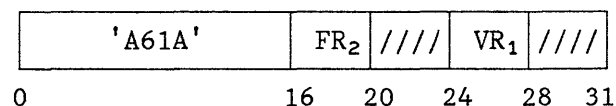

Partial-sum elements of the first-operand vector are added to the scalar second operand, the result replacing the second operand.

The operand elements are floating-point numbers in the long format, and every addition is performed in the same manner as for the scalar ADD NORMALIZED (ADR) instruction, except that the condition code is not set. The operation begins with adding element *X* of the first operand to the second operand, where *X* is the initial vector interruption index (normally zero). It proceeds in an ascending sequence of element numbers by successively adding *p-X* first-operand elements, where *p* is the model-dependent partial-sum number. The last one to be added is element *p-1*. The vector interruption index is then set to zero.

If the initial vector interruption index *X* is equal to or greater than *p*, no elements are processed, and the scalar second operand remains unchanged. The vector interruption index is set to zero, and instruction execution is completed.

A specification exception is recognized when the VR₁ or FR₂ field designates an invalid register number.

SUM PARTIAL SUMS is a class-IP instruction: it is interruptible, the partial-sum number and vector interruption index determine the number of elements processed, and its execution is not affected by the vector-mask mode. The vector count is not used and remains unchanged.

Condition Code: The code remains unchanged.

Program Exceptions:

- Exponent overflow (with exception-extension code)
- Exponent underflow (with exception-extension code)
- Operation
- Significance (with exception-extension code)
- Specification
- Vector operation

Programming Note

An example of the use of SUM PARTIAL SUMS is given in Appendix A (see "Sum of Products" on page A-3).

TEST VMR

VTVM [RRE]

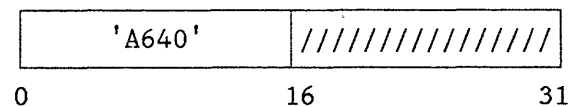

The active bits of the vector-mask register are tested, and condition code 0, 1, or 3 is set according to whether those bits are all zeros, mixed zeros and ones, or all ones.

When the vector count is zero, condition code 0 is set.

TEST VMR is a class-NC instruction: it is not interruptible, the vector count determines the number of elements processed, and its execution is not affected by the vector-mask mode.

Resulting Condition Code:

- 0 Active bits all zeros
- 1 Active bits mixed zeros and ones
- 2 --
- 3 Active bits all ones

Program Exceptions:

Operation
Vector operation

Programming Note

The instruction TEST VMR performs the testing portion of the instructions COUNT LEFT ZEROS IN VMR and COUNT ONES IN VMR. It may be used to distinguish the all-zeros and all-ones conditions when the exact count is not required.

ZERO PARTIAL SUMS

VZPSD VR₁ [VR]

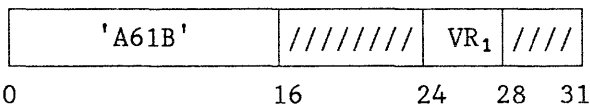

Partial-sum element locations of the vector-register pair designated by VR₁ are set to zero.

The operation begins with setting to zero element *X* of the first operand, where *X* is the initial vector inter-

ruption index (normally zero). It proceeds in an ascending sequence of element numbers by successively setting to zero *p-X* first-operand elements, where *p* is the model-dependent partial-sum number. The last one is element *p-1*. The vector interruption index is then set to zero.

If the initial vector interruption index *X* is equal to or greater than *p*, the vector-register contents and the associated vector in-use bit and vector change bit remain unchanged. The vector interruption index is set to zero, and instruction execution is completed.

A specification exception is recognized if the VR₁ field designates an invalid register number.

ZERO PARTIAL SUMS is a class-IP instruction: it is interruptible, the partial-sum number and vector interruption index determine the number of elements processed, and its execution is not affected by the vector-mask mode. The vector count is not used by the instruction and remains unchanged.

Condition Code: The code remains unchanged.

Program Exceptions:

Operation
Specification
Vector operation

Programming Note

An example of the use of ZERO PARTIAL SUMS is given in Appendix A (see "Sum of Products" on page A-3).

APPENDIX A. INSTRUCTION-USE EXAMPLES

This appendix contains a number of simple examples of the use of vector instructions.

Every example has a sectioning loop, so that vectors of any length can be handled, independent of the section size. The first example illustrates sectioning in some detail; the others use the same or a similar technique.

The examples are written in assembler language. Register operands are indicated symbolically with a prefix G, F, or V to identify more clearly whether an operand refers to a general register, floating-point register, or vector register, respectively.

Comments are written to the right of the instruction or on separate lines that begin with an asterisk (*).

OPERATIONS ON FULL VECTORS

The following examples illustrate operations on full vectors, where both zero and nonzero elements are represented in storage. Vectors in storage are accessed by sequential addressing.

The first three examples use three different methods of controlling the sectioning loop.

Contiguous Vectors

Two contiguous vectors *A* and *B* in storage are added, and the result is stored in contiguous vector *C*. The number of elements in each is specified by *N*. All vectors are in the long floating-point format.

	$C = A + B$	
*		
*		
	L G0,N	Vector length to GR0
	LA G1,A	Address of <i>A</i> to GR1
	LA G2,B	Address of <i>B</i> to GR2
	LA G3,C	Address of <i>C</i> to GR3
LP	VLVCU G0	Load VCT, update GR0
	VLD V0,G1	Load section of <i>A</i>
	VAD V0,V0,G2	Add section of <i>B</i>
	VSTD V0,G3	Store section in <i>C</i>
	BC 2,LP	Test condition code set by VLVCU, branch if not last section
*		
*		

Assuming, for purposes of illustration, a vector-section size of 8 and a vector length of 20, the above program would process three sections in turn (two full sections of eight elements and one partial section of four elements) before ending the loop. One section of *A* and one section of *B* are added in vector-register pair 0 and 1. The result is stored in a section of *C*, as illustrated below:

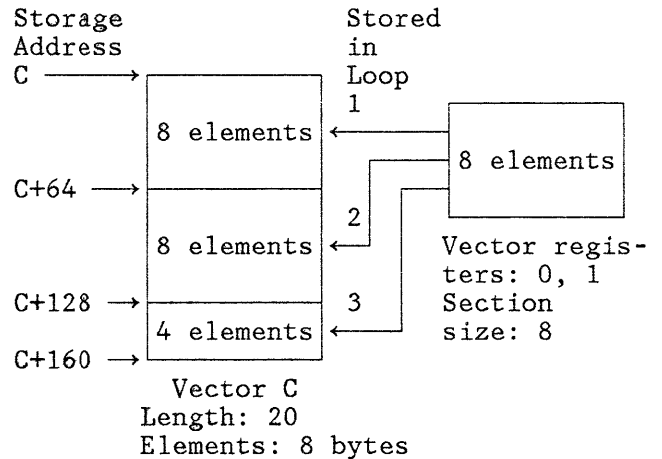

Since all vectors are stored contiguously, the stride for the three vector instructions VLD, VAD, and VSTD is set to one by specifying a value of zero in the RT₂ subfield. This may be done in

the assembler language either by placing a zero inside the parentheses of the stride subfield, as in:

Mnemonic VR₁,VR₃,RS₂(0)

or by omitting the subfield, including the parentheses, altogether:

Mnemonic VR₁,VR₃,RS₂

Each of these instructions automatically updates the storage address in the designated general register to the value that will be needed for the next time, if any, around the loop.

The BRANCH ON CONDITION (BC) instruction tests the condition code set by VLVCU, because none of the intervening instructions change the condition code. If an instruction setting the condition code had intervened, the instruction "LTR GO,GO" inserted before the BC instruction would test the contents of GR0; BC would test for condition code 2 in either case.

The following figure shows the condition-code setting (CC), the vector count (VCT), and the contents of the general registers at the start, before executing the first VLVCU instruction, and at the end of each loop thereafter.

Loop	CC	VCT	GR0	GR1	GR2	GR3
Start	-	-	20	A	B	C
End 1	2	8	12	A+64	B+64	C+64
End 2	2	8	4	A+128	B+128	C+128
End 3	3	4	0	A+160	B+160	C+160

Vectors with Stride

This example modifies the previous example in four ways. All vector elements are in the short floating-point format. The result of the addition is returned to the storage location of vector *B*. Vector *B* is assumed to be stored with a stride *T*. Finally, a BC instruction which tests for the end of the loop is placed immediately after the VLVCU instruction, and the loop is closed with an unconditional branch.

This method, which could be used if additional instructions were to change the condition code later in the loop, allows the loop to be bypassed when the initial vector count is zero. (Note, however, that the previous loop control also works with a vector count of zero, because no elements would be processed if vector instructions were executed with a zero vector count.)

```

*           B = A + B
*
L   GO,N   Vector length to GR0
LA  G1,A   Address of A to GR1
LA  G2,B   Address of B to GR2
LR  G3,G2  Copy address in GR3
L   G4,T   Stride for B to GR4
LP  VLVCU  GO   Load VCT, update GR0
BC  12,NXT Exit loop if VCT=0
VLE V0,G1   Load section of A
VAE V0,V0,G2(G4)
*
VSTE V0,G3(G4) Return section to B
BC  15,LP   Branch to loop start
NXT Next instruction

```

Two registers, GR2 and GR3, are used to specify the current address of *B*, so that the two instructions VAE and VSTE in the sectioning loop will refer to the same section. Each of the two instructions updates its separate copy of the address. (If a vector in storage is referred to more than twice within a sectioning loop, the address could be copied inside the loop for each use except the last, so as to reduce the number of general registers needed.)

Vector and Scalar Operands

This example illustrates the use of both vector and scalar operands. It also shows how the three-operand arithmetic vector instructions can sometimes be used to avoid a separate vector-load instruction. A third loop-control method is used here.

A and *B* are vectors of length *N*, and *S* is a scalar. All are in the long floating-point format.

```

*           B = A * (S-A)
*
L   G0,N   Vector length to GR0
LA  G1,A   Address of A to GR1
LR  G2,G1  Copy address in GR2
LA  G3,B   Address of B to GR3
LD  F0,S   Load S into FRO
VLVCU G0   Load VCT, update GR0
LP  VSIDS V0,F0,G1 Compute S-A
VMD  V0,V0,G2 Compute A*(S-A)
VSTD V0,G3  Store result in B
VLVCU G0   Load VCT, update GR0
BC  3,LP   Branch back if VCT>0

```

The VSIDS instruction subtracts vector *A* in storage from the scalar *S*. VMD multiplies the result by vector *A*, again from its storage location. VSTD stores the product as *B*. There are two VLVCU loop-control instructions, one before entry into the loop and one at the end.

Note that the QST-format arithmetic instruction (VSIDS) saves a separate load instruction at the expense of having to access storage twice for the same vector section *A*. Depending on the model, a separate load instruction followed by QV-format arithmetic instructions may be more efficient in some circumstances, particularly when the stride is greater than one.

Note further that the QST-format instructions are defined such that VSIDS subtracts a vector from a scalar (*S-V*). Subtracting a scalar from a vector (*V-S*) can be done conveniently by first changing the sign of the scalar and then adding, using VADS. Similarly, the VDDS instruction divides a scalar by a vector (*S/V*). Division of a vector by a scalar (*V/S*) can be performed by first taking the reciprocal of the scalar and then multiplying, using VMDS. (The same comment applies to the corresponding QV-format instructions.)

Sum of Products

The use of MULTIPLY AND ACCUMULATE and related instructions is illustrated by computing the inner product of a row vector *A*, taken from a matrix of dimensions *I* by *J*, and a column vector *B*, taken from another matrix of dimensions

J by *K*. Each matrix is assumed to be stored in column order. Therefore, row vector *A* has a stride *I* and a length *J*, and column vector *B* is contiguous and has the same length *J*. The inner product of the two vectors is a scalar value that is the sum of the element-by-element products of vectors *A* and *B*; it is stored at address *C*.

```

*           C = SUM (A * B)
*
L   G0,J   Vector length to GR0
LA  G1,A   Address of A to GR1
L   G2,I   Stride for A to GR2
LA  G3,B   Address of B to GR3
VZPSD V0   Zero partial sums
LP  VLVCU G0 Load VCT, update GR0
VLD  V2,G1(G2) Row A section to VR2
VMCD V0,V2,G3 Multiply by column B
*
BC  2,LP   Branch back if GR0>0
SDR  F0,F0 Clear FRO to zero
VSPSD V0,F0 Scalar sum to FRO
STD  F0,C   Store scalar sum

```

First the VZPSD instruction clears the partial-sum locations in VRO to zero. Then the sectioning loop accumulates partial sums: The VLD instruction loads a section of row *A* (with stride) into VR2. The VMCD instruction multiplies the elements of row *A* in VR2 by elements of column *B* in storage (without stride) and accumulates *p* partial sums in VRO; the number *p* depends on the model.

After the sectioning loop is ended and all partial sums have been accumulated in VRO, FRO is cleared by means of SDR, and the *p* partial sums are then added to FRO by use of the VSPSD instruction. The scalar sum is stored in *C* by STD.

Note that the program is independent of the vector-section size and the number of partial sums, both of which depend on the model, because the instructions VZPSD, VLVCU, VMCD, and VSPSD take care of these dependencies automatically.

Compare and Swap Vector Elements

Two vectors A and B , both of length N , are to be compared and their elements swapped so that vector A will have the smaller element of each pair and vector B the larger. The elements are 32-bit signed binary integers and stored contiguously.

L	G0,N	Vector length to GR0
LA	G1,A	Address of A to GR1
LR	G2,G1	Copy address in GR2
LA	G3,B	Address of B to GR3
LR	G4,G3	Copy address in GR4
LP	VLVCU G0	Load VCT, update GR0
VL	V0,G1	Section of A to VR0
VL	V1,G3	Section of B to VR1
VCR	2,V0,V1	Check where $A > B$
VSTM	V0,G4	Store greater in B
VSTM	V1,G2	Store lesser in A
BC	2,LP	Branch back if GR0 > 0

*		$C = A / B$	
*			
	L	G0,N	Vector length to GR0
	LA	G1,A	Address of A to GR1
	LA	G2,B	Address of B to GR2
	LR	G3,G2	Copy address in GR3
	LA	G4,C	Address of C to GR4
	SDR	F0,F0	Clear FR0 to zero
	LD	F2,MP	Load max. positive number MP in FR2
*			
	VSVMM	1	Vector-mask mode on
LP	VLVCU	G0	Load VCT, update GR0
	VCDS	6,F0,G2	Compare section of B not equal to zero
*			
	VLDQ	V0,F2	Load MP in all elem. positions of VR0
*			
	VLD	V2,G1	Load section of A
	VDD	V0,V2,G3	Conditionally divide A by section of B
*			
	VSTD	V0,G4	Store section in C
	BC	2,LP	Branch back if GR0 > 0
	VSVMM	0	Set mask mode off

CONDITIONAL ARITHMETIC

Exception Avoidance

One use of conditional arithmetic in the vector-mask mode is to bypass vector elements which would cause an exception during the arithmetic operation and to provide a predetermined alternate result for those elements. The example divides two vectors A and B . The divisor B is tested for zeros. By using the vector-mask mode, no division is performed for zero divisor elements, thus avoiding a disruptive floating-point-divide exception; the corresponding elements in result vector C are set to the maximum positive value MP . All floating-point numbers are in the long format.

In this example, performing the arithmetic conditionally requires two extra vector instructions inside the sectioning loop.

Add to Magnitude

Another use of conditional arithmetic is to perform addition to the magnitude of a vector regardless of signs. This may be illustrated by rounding a vector V of length N , consisting of floating-point numbers in the short format, to integer values. First, 0.5 is added to the magnitude of each element. Then, the digits to the right of the implied radix point are truncated. The rounded vector R remains in the short floating-point format.

Let H and Z be constants with the following hexadecimal formats and values:

$$H = 40\ 80\ 00\ 00 = 0.5$$

$$Z = 47\ 00\ 00\ 00 = 0 \text{ (unnormalized)}$$

H is the value which is to be added to or subtracted from each vector element, depending on its sign.

The constant Z is an unnormalized zero with such a characteristic that its addition to a short floating-point number having a smaller characteristic forces that number to be shifted to the right, placing the units digit in the guard-digit position. This causes any digits to the right of the implied radix point to be truncated and the result to

be normalized. Any number with an equal or larger characteristic has no significant digits to the right of the implied radix point and remains unchanged.

*		$R = \text{ROUND}(V)$	
*			
	L	G0,N	Vector length to GR0
	LA	G1,V	Address of V to GR1
	LA	G2,R	Address of R to GR2
	SDR	F0,F0	Clear FR0 to zero
	LE	F2,H	Load H into FR2
	LNER	F4,F2	Load $-H$ into FR4
	LE	F6,Z	Load Z into FR6
LP	VLVCU	G0	Load VCT, update GR0
	VLE	V0,G1	Load section of V
	VSVMM	1	Vector-mask mode on
	VCEQ	12,F0,V0	Compare; set mask to one where $0 \leq V$
*			
	VAEQ	V0,F2,V0	Add 0.5 under mask
	VCVM		Complement mask bits
	VAEQ	V0,F4,V0	Add -0.5 under mask
	VSVMM	0	Vector-mask mode off
	VAEQ	V0,F6,V0	Add Z
	VSTE	V0,G2	Store section of R
	BC	2,LP	Branch back if GR0>0

A variation of this rounding technique is incorporated in a later example of floating-point to fixed-point conversion.

OPERATIONS ON SPARSE VECTORS

This section gives some examples of operating on sparse vectors, where only nonzero elements are directly represented in storage.

When many vector elements are zero, considerable storage may be saved by using a dense representation containing only those elements which are nonzero. The resulting nonzero elements can be stored in contiguous locations along with a bit vector indicating the nonzero values in the corresponding full vector. A full vector can be converted to such a dense vector by performing a not-equal comparison of the vector to a scalar zero and using the resulting bit vector as a mask in a STORE COMPRESSED instruction.

For use in the following examples, assume two vectors A and B . The full vectors are 10 elements in length; ele-

ments 0, 2, 5, 6, 7, and 9 of vector A are nonzero; and elements 2, 4, 5, and 7 of vector B are nonzero. The figures show the full vectors, the result of a not-equal comparison to zero, and the dense vectors for A and B .

Full Vector A (AF):

A0	A1	A2	A3	A4	A5	A6	A7	A8	A9
----	----	----	----	----	----	----	----	----	----

Result of comparing $A \neq 0$ (mask AM):

1 0 1 0 0 1 1 1 0 1

Dense Vector A (AD):

A0	A2	A5	A6	A7	A9
----	----	----	----	----	----

Full Vector B (BF):

B0	B1	B2	B3	B4	B5	B6	B7	B8	B9
----	----	----	----	----	----	----	----	----	----

Result of comparing $B \neq 0$ (mask BM):

0 0 1 0 1 1 0 1 0 0

Dense Vector B (BD):

B2	B4	B5	B7
----	----	----	----

Full Added to Sparse to Give Full

This example shows the addition of elements of full vector BF , which correspond to nonzero elements of vector A , to dense vector AD . The result elements are replaced in BF . The length of the full vectors is N , which is also the number of bits in the mask.

	LA	G0,AD	Address of AD to GR0
	SR	G2,G2	Clear bit index, GR2
	L	G3,N	Set bit count N , GR3
LP	VLBIX	V0,G2,AM	Convert mask AM to element numbers, VR0
*			
	VLID	V2,V0,BF	Load BF indirectly
	VAD	V2,V2,G0	Add AD contiguously
	VSTID	V2,V0,BF	Store indirectly
	BC	2,LP	Branch back if GR3>0

The VLBIX instruction converts the bit mask *AM* to a vector of element numbers, using the general-register pair GR2 and GR3 as the bit index and bit count. This instruction creates up to a full section of element numbers in VR0 and places the corresponding vector count in VCT for use by subsequent vector instructions. GR2 and GR3 are updated for the next pass through the loop. VLID uses the generated element numbers to select elements of full *BF* to correspond to all the elements of dense *AD*, which are added together by the instruction VAD. VSTID then stores the results back into the same elements of *BF*. The BC instruction tests the condition code set by VLBIX and branches back if there are more bits to be processed.

Sparse Added to Sparse to Give Sparse

The following example adds dense vectors *AD* and *BD* to obtain dense vector *CD*. The mask for *CD* is obtained by ORing the mask for *AD* with the mask for *BD*, using the instruction OR TO VMR.

LA	G0,AD	Address of <i>AD</i> to GR0
LA	G1,BD	Address of <i>BD</i> to GR1
LA	G2,CD	Address of <i>CD</i> to GR2
LA	G3,AM	Address of <i>AM</i> to GR3
LR	G4,G3	Copy address in GR4
LA	G5,BM	Address of <i>BM</i> to GR5
LA	G6,CM	Address of <i>CM</i> to GR6
L	G7,N	Length of full
*		vectors to GR7
LP	VLVCU G7	Load VCT, update GR7
	VLVM G3	Load mask <i>AM</i> in VMR
	VLZDR V0	Zeros into VR0, VR1
	VLYD V0,G0	Load <i>AD</i> expanded: <i>AF</i>
	VLVM G5	Load mask <i>BM</i> in VMR
	VLZDR V2	Zeros into VR2, VR3
	VLYD V2,G1	Load <i>BD</i> expanded: <i>BF</i>
	VADR V0,V0,V2	Add <i>BF</i> to <i>AF</i>
	VOVM G4	or mask <i>AM</i> into VMR
	VSTKD V0,G2	Store compressed: <i>CD</i>
	VSTVM G6	Store VMR as mask <i>CM</i>
	BC 2,LP	Branch back if GR7>0

FLOATING-POINT-VECTOR CONVERSIONS

The conversion techniques illustrated here are similar to the scalar examples in *IBM 370-XA Principles of Operation* and *IBM System/370 Principles of Operation* which may be consulted for more details. The methods differ, however, because of different characteristics of the vector-instruction set.

Fixed Point to Floating Point

Assume a vector *K* of length *N* in storage, the elements of which are 32-bit signed binary integers. The elements are to be converted to floating-point numbers in the long format, and the result is to be stored as vector *W*.

Assume a floating-point constant *C* in storage with the following hexadecimal format and value:

$$C = \text{CE 00 00 00 80 00 00 00} = -2^{31}$$

This is an unnormalized floating-point number in the long format with the characteristic 4E, which is the proper characteristic for a right-aligned, unnormalized integer.

LA	G0,K	Address of <i>K</i> to GR0
LA	G1,W	Address of <i>W</i> to GR1
L	G2,N	Vector length to GR2
LD	F0,C	Load <i>C</i> into FRO
LP	VLVCU G2	Load VCT, update GR2
VL	V1,G0	Load <i>K</i> into VR1
VLCER	V1,V1	$K + 2^{31}$
VLEQ	V0,F0	$V = -(K + 2^{31})$
VSDQ	V0,F0,V0	$W = -2^{31} - V$
VSTD	V0,G1	Store <i>W</i>
BC	2,LP	Branch back if GR2>0

Inside the sectioning loop, the VLCER instruction (LOAD COMPLEMENT in short floating-point format) inverts the sign bit, bit 0, of each element in VR1, without altering bits 1-31. Considering these elements still as signed binary integers, the operation is equivalent to adding 2^{31} to each, ignoring overflow, which changes all elements into positive numbers in the range 0 to $2^{32}-1$. The VLEQ instruction places the left half of

the constant C into each element position of VR0, which has the effect of converting the contents of VR1 to a vector V of negative unnormalized floating-point numbers in the long format, occupying VR0 and VR1.

The next instruction, VSDQ, subtracts V from the entire constant C , which is equivalent to subtracting 2^{31} from the original elements, thus restoring them to the range -2^{31} to $2^{31}-1$. The elements are normalized during this operation.

The next example presents an alternate program, the loop of which is shorter by one vector instruction.

	LA	G0,K	Address of K to GR0
	LA	G1,W	Address of W to GR1
	L	G2,N	Vector length to GR2
	LD	F0,C	Load C into FR0
LP	VLVCU	G2	Load VCT, update GR2
	VLDQ	V0,F0	Load C into VR0, VR1
	VX	V1,V1,G0	$V = -(K+2^{31})$
	VSDQ	V0,F0,V0	$W = -2^{31} - V$
	VSTD	V0,G1	Store W
	BC	2,LP	Branch back if GR2>0

The VLDQ instruction loads the entire constant C into VR0 and VR1. Then, the VX instruction fetches the elements of K from storage and EXCLUSIVE ORs them into VR1, which contained a leftmost one followed by 31 zeros. This inverts the sign bit, as did VLCER in the previous example. The rest of the program is the same.

Floating Point to Fixed Point

This example combines conversion from floating to fixed point with a variation of the rounding technique shown in a previous example.

* Start of range test			
	LA	G0,W	Address of W to GR0
	LR	G1,G0	Copy address to GR1
	L	G2,N	Vector length to GR2
	LD	F0,L	FR0: upper limit L
	LNDR	F2,F0	FR2: lower limit $-L$
LP1	VLVCU	G2	Load VCT, update GR2
	VCDS	12,F0,G0	Compare L and W ; set mask bit to one when
*			L is equal or low
*	VTVM		Test mask bits
	BC	5,OVFLO	Exit if any ones
	VCDS	2,F2,G1	Compare $-L$ and W ; set mask bit to one when $-L$ is high
*			
*	VTVM		Test mask bits
	BC	5,OVFLO	Exit if any ones
	LTR	G2,G2	Test residual count
	BC	2,LP1	Branch back if GR2>0
* Start of conversion with rounding			
	LA	G0,W	Address of W to GR0
	LA	G1,K	Address of K to GR1
	L	G2,N	Vector length to GR2
	LD	F0,G	Load G into FR0
	LD	F2,H	Load H into FR2
	LD	F4,M	Load M into FR4
LP2	VLVCU	G2	Load VCT, update GR2
	VADS	V0,F2,G0	Add 0.5 to W section
	VSVMM	1	Vector-mask mode on
	VCDQ	2,F2,V0	Compare; set mask to one where $0.5 > W$
*			
	VADQ	V0,F4,V0	Add -1.0 under mask
	VSVMM	0	Set mask mode off
	VADQ	V0,F0,V0	Add 2^{53}
	VST	V1,G1	Store K from VR1
	BC	2,LP2	Branch back if GR2>0

Assume a vector W of length N in storage, the elements of which are floating-point numbers in the long format. Assume this vector is to be converted to a vector of signed binary integers, and the result is to be stored as vector K . Assume floating-point constants in storage with the following names, hexadecimal formats, and values:

$$L = 48\ 80\ 00\ 00\ 00\ 00\ 00\ 00 = 2^{31}$$

$$G = 4F\ 02\ 00\ 00\ 00\ 00\ 00\ 00 = 2^{53}$$

$$H = 40\ 80\ 00\ 00\ 00\ 00\ 00\ 00 = 0.5$$

$$M = C1\ 10\ 00\ 00\ 00\ 00\ 00\ 00 = -1.0$$

L is the upper limit of the range of numbers which, after truncation of the fractional part, are representable as signed binary integers. Vector W is compared with this limit in a separate

sectioning loop before conversion is started, so that nothing is stored if any element of W is out of range. This comparison loop can be omitted if all elements are known to be within range.

H and M are the constants 0.5 and -1.0, respectively. Rounding is accomplished by first adding 0.5 unconditionally to vector W , and then adding -1.0 conditionally where the elements are now less than 0.5, which is equivalent to sub-

tracting 0.5 from all initially negative elements.

The constant G is chosen such that its addition to a number within the representable range forces that number to be shifted to the right, with the units digit in the guard-digit position, and the result to be normalized to the left by one digit position. This causes any fraction part to be truncated, leaving the rounded integer part in the right half of the vector-register pair.

APPENDIX B. LISTS OF INSTRUCTIONS

The following figures list the vector instructions by name, mnemonic, and op code.

Explanation of Symbols in "Characteristics" Column

A Access exceptions
 C Condition code is set
 EO Exponent-overflow exception
 EU Exponent-underflow exception
 FK Floating-point-divide exception
 IC Class-IC instruction; interruptible; vector count and vector interruption index determine number of elements processed; does not depend on vector-mask mode
 IF Fixed-point-overflow exception
 IG Class-IG instruction; interruptible; general register, vector interruption index, and section size determine number of elements processed; sets vector count; does not depend on vector-mask mode
 IM Class-IM instruction; interruptible; vector count and vector interruption index determine number of elements processed; depends on vector-mask mode
 IP Class-IP instruction; interruptible; partial-sum number and vector interruption index determine number of elements processed; does not depend on vector-mask mode
 IZ Class-IZ instruction; interruptible; vector-section size determines number of elements processed; does not depend on vector-mask mode
 J Arithmetic exception; exception-extension code is stored
 LS Significance exception
 NC Class-NC instruction; not interruptible; vector count determines number of elements processed; does not depend on vector-mask mode

NZ Class-NZ instruction; not interruptible; vector-section size determines number of elements processed; does not depend on vector-mask mode
 NO Class-NO instruction; not interruptible; no vector elements processed; does not depend on vector-mask mode
 N1 Class-N1 instruction; not interruptible; one vector element processed; does not depend on vector-mask mode
 P Privileged-operation exception
 QST QST instruction format
 QV QV instruction format
 R* PER general-register-alteration event may or may not be recognized
 RRE RRE instruction format
 RSE RSE instruction format
 S S instruction format
 SP Specification exception
 ST PER storage-alteration event
 U Unnormalized-operand exception
 VB Sets vector in-use bit and vector change bit
 VE Vector facility and vector-operation exception
 VH Sets vector change bit
 VR VR instruction format
 VS VS instruction format
 VST VST instruction format
 VU Leaves vector change bit unaltered
 VV VV instruction format

Notes

- ¹ Same op code as for short; separate mnemonic for programming convenience
- ² Execution differs in problem state and supervisor state

Name	Mne- monic	Characteristics										Op Code		
ACCUMULATE (long)	VACD	VST	VE	A	SP	J	EU	EO	LS	IM	VB	R*	A417	
ACCUMULATE (long)	VACDR	VV	VE		SP	J	EU	EO	LS	IM	VB		A517	
ACCUMULATE (short to long)	VACE	VST	VE	A	SP	J	EU	EO	LS	IM	VB	R*	A407	
ACCUMULATE (short to long)	VACER	VV	VE		SP	J	EU	EO	LS	IM	VB		A507	
ADD (binary)	VA	VST	VE	A	SP	J		IF		IM	VB	R*	A420	
ADD (binary)	VAQ	QV	VE			J		IF		IM	VB		A5A0	
ADD (binary)	VAR	VV	VE			J		IF		IM	VB		A520	
ADD (binary)	VAS	QST	VE	A	SP	J		IF		IM	VB	R*	A4A0	
ADD (long)	VAD	VST	VE	A	SP	J	EU	EO	LS	IM	VB	R*	A410	
ADD (long)	VADQ	QV	VE		SP	J	EU	EO	LS	IM	VB		A590	
ADD (long)	VADR	VV	VE		SP	J	EU	EO	LS	IM	VB		A510	
ADD (long)	VADS	QST	VE	A	SP	J	EU	EO	LS	IM	VB	R*	A490	
ADD (short)	VAE	VST	VE	A	SP	J	EU	EO	LS	IM	VB	R*	A400	
ADD (short)	VAEQ	QV	VE		SP	J	EU	EO	LS	IM	VB		A580	
ADD (short)	VAER	VV	VE			J	EU	EO	LS	IM	VB		A500	
ADD (short)	VAES	QST	VE	A	SP	J	EU	EO	LS	IM	VB	R*	A480	
AND	VN	VST	VE	A	SP					IM	VB	R*	A424	
AND	VNQ	QV	VE							IM	VB		A5A4	
AND	VNR	VV	VE							IM	VB		A524	
AND	VNS	QST	VE	A	SP					IM	VB	R*	A4A4	
AND TO VMR	VNVM	VS	VE	A						NC		R*	A684	
CLEAR VR	VRCL	S	VE							IZ	VB		A6C5	
COMPARE (binary)	VC	VST	VE	A	SP					IC		R*	A428	
COMPARE (binary)	VCQ	QV	VE							IC			A5A8	
COMPARE (binary)	VCR	VV	VE							IC			A528	
COMPARE (binary)	VCS	QST	VE	A	SP					IC		R*	A4A8	
COMPARE (long)	VCD	VST	VE	A	SP					IC		R*	A418	
COMPARE (long)	VCDQ	QV	VE		SP					IC			A598	
COMPARE (long)	VCDR	VV	VE		SP					IC			A518	
COMPARE (long)	VCDSD	QST	VE	A	SP					IC		R*	A498	
COMPARE (short)	VCE	VST	VE	A	SP					IC		R*	A408	
COMPARE (short)	VCEQ	QV	VE		SP					IC			A588	
COMPARE (short)	VCER	VV	VE							IC			A508	
COMPARE (short)	VCES	QST	VE	A	SP					IC		R*	A488	
COMPLEMENT VMR	VCVM	RRE	VE							NC			A641	
COUNT LEFT ZEROS IN VMR	VCZVM	RRE	C	VE						NC		R*	A642	
COUNT ONES IN VMR	VCZVM	RRE	C	VE						NC		R*	A643	
DIVIDE (long)	VDD	VST	VE	A	SP	J	U	EU	EO	FK	IM	VB	R*	A413
DIVIDE (long)	VDDQ	QV	VE		SP	J	U	EU	EO	FK	IM	VB		A593
DIVIDE (long)	VDDR	VV	VE		SP	J	U	EU	EO	FK	IM	VB		A513
DIVIDE (long)	VDDS	QST	VE	A	SP	J	U	EU	EO	FK	IM	VB	R*	A493
DIVIDE (short)	VDE	VST	VE	A	SP	J	U	EU	EO	FK	IM	VB	R*	A403
DIVIDE (short)	VDEQ	QV	VE		SP	J	U	EU	EO	FK	IM	VB		A583
DIVIDE (short)	VDER	VV	VE			J	U	EU	EO	FK	IM	VB		A503
DIVIDE (short)	VDES	QST	VE	A	SP	J	U	EU	EO	FK	IM	VB	R*	A483

Figure B-1 (Part 1 of 4). Instructions Arranged by Name

Name	Mne- monic	Characteristics						Op Code		
EXCLUSIVE OR	VX	VST	VE	A	SP	IM	VB	R*	A426	
EXCLUSIVE OR	VXQ	QV	VE			IM	VB		A5A6	
EXCLUSIVE OR	VXR	VV	VE			IM	VB		A526	
EXCLUSIVE OR	VXS	QST	VE	A	SP	IM	VB	R*	A4A6	
EXCLUSIVE OR TO VMR	VXVM	VS	VE	A		NC		R*	A686	
EXTRACT ELEMENT (binary)	VXEL	VR	VE		SP	N1		R*	A629	
EXTRACT ELEMENT (long)	VXELD	VR	VE		SP	N1			A619	
EXTRACT ELEMENT (short)	VXELE	VR	VE		SP	N1			A609	
EXTRACT VCT	VXVC	RRE	VE			NO		R*	A644	
EXTRACT VECTOR MASK MODE	VXVMM	RRE	VE			NO		R*	A646	
LOAD (binary) ¹	VL	VST	VE	A	SP	IC	VB	R*	A409	
LOAD (binary)	VLQ	QV	VE			IC	VB		A5A9	
LOAD (binary) ¹	VLR	VV	VE			IC	VB		A509	
LOAD (long)	VLD	VST	VE	A	SP	IC	VB	R*	A419	
LOAD (long)	VLDQ	QV	VE		SP	IC	VB		A599	
LOAD (long)	VLDR	VV	VE		SP	IC	VB		A519	
LOAD (short)	VLE	VST	VE	A	SP	IC	VB	R*	A409	
LOAD (short)	VLEQ	QV	VE		SP	IC	VB		A589	
LOAD (short)	VLER	VV	VE			IC	VB		A509	
LOAD BIT INDEX	VLBIX	RSE	C	VE	A	SP	IG	VB	R*	E428
LOAD COMPLEMENT (binary)	VLCR	VV	VE			J	IF	IM	VB	A562
LOAD COMPLEMENT (long)	VLCDR	VV	VE		SP			IM	VB	A552
LOAD COMPLEMENT (short)	VLCDR	VV	VE					IM	VB	A542
LOAD ELEMENT (binary)	VLEL	VR	VE		SP	N1	VB		A628	
LOAD ELEMENT (long)	VLELD	VR	VE		SP	N1	VB		A618	
LOAD ELEMENT (short)	VLELE	VR	VE		SP	N1	VB		A608	
LOAD EXPANDED (binary) ¹	VLY	VST	VE	A	SP	IC	VB	R*	A40B	
LOAD EXPANDED (long)	VLYD	VST	VE	A	SP	IC	VB	R*	A41B	
LOAD EXPANDED (short)	VLYE	VST	VE	A	SP	IC	VB	R*	A40B	
LOAD HALFWORD	VLH	VST	VE	A	SP	IC	VB	R*	A429	
LOAD INDIRECT (binary) ¹	VLI	RSE	VE	A	SP	IC	VB		E400	
LOAD INDIRECT (long)	VLID	RSE	VE	A	SP	IC	VB		E410	
LOAD INDIRECT (short)	VLIE	RSE	VE	A	SP	IC	VB		E400	
LOAD INTEGER VECTOR	VLINT	VST	VE		SP	IC	VB	R*	A42A	
LOAD MATCHED (binary) ¹	VLM	VST	VE	A	SP	IC	VB	R*	A40A	
LOAD MATCHED (binary)	VLMQ	QV	VE			IC	VB		A5AA	
LOAD MATCHED (binary) ¹	VLMR	VV	VE			IC	VB		A50A	
LOAD MATCHED (long)	VLMD	VST	VE	A	SP	IC	VB	R*	A41A	
LOAD MATCHED (long)	VLMDQ	QV	VE		SP	IC	VB		A59A	
LOAD MATCHED (long)	VLMDR	VV	VE		SP	IC	VB		A51A	
LOAD MATCHED (short)	VLME	VST	VE	A	SP	IC	VB	R*	A40A	
LOAD MATCHED (short)	VLMEQ	QV	VE		SP	IC	VB		A58A	
LOAD MATCHED (short)	VLMER	VV	VE			IC	VB		A50A	
LOAD NEGATIVE (binary)	VLNR	VV	VE			IM	VB		A561	
LOAD NEGATIVE (long)	VLNDR	VV	VE		SP	IM	VB		A551	

Figure B-1 (Part 2 of 4). Instructions Arranged by Name

Name	Mne- monic	Characteristics						Op Code
LOAD NEGATIVE (short)	VLNER	VV	VE				IM VB	A541
LOAD POSITIVE (binary)	VLPR	VV	VE			J	IF IM VB	A560
LOAD POSITIVE (long)	VLPDR	VV	VE	SP			IM VB	A550
LOAD POSITIVE (short)	VLPER	VV	VE				IM VB	A540
LOAD VCT AND UPDATE	VLVCU	RRE	C VE				NO R*	A645
LOAD VCT FROM ADDRESS	VLVCA	S	C VE				NO	A6C4
LOAD VMR	VLVM	VS	VE	A			NC R*	A680
LOAD VMR COMPLEMENT	VLCVM	VS	VE	A			NC R*	A681
LOAD ZERO (binary) ¹	VLZR	VV	VE				IC VB	A50B
LOAD ZERO (long)	VLZDR	VV	VE	SP			IC VB	A51B
LOAD ZERO (short)	VLZER	VV	VE				IC VB	A50B
MAXIMUM ABSOLUTE (long)	VMXAD	VR	VE	SP			IM R*	A612
MAXIMUM ABSOLUTE (short)	VMXAE	VR	VE	SP			IM R*	A602
MAXIMUM SIGNED (long)	VMXSD	VR	VE	SP			IM R*	A610
MAXIMUM SIGNED (short)	VMXSE	VR	VE	SP			IM R*	A600
MINIMUM SIGNED (long)	VMNSD	VR	VE	SP			IM R*	A611
MINIMUM SIGNED (short)	VMNSE	VR	VE	SP			IM R*	A601
MULTIPLY (binary)	VM	VST	VE	A SP			IM VB R*	A422
MULTIPLY (binary)	VMQ	QV	VE	SP			IM VB	A5A2
MULTIPLY (binary)	VMR	VV	VE	SP			IM VB	A522
MULTIPLY (binary)	VMS	QST	VE	A SP			IM VB R*	A4A2
MULTIPLY (long)	VMD	VST	VE	A SP	J U EU EO		IM VB R*	A412
MULTIPLY (long)	VMDQ	QV	VE	SP	J U EU EO		IM VB	A592
MULTIPLY (long)	VMDR	VV	VE	SP	J U EU EO		IM VB	A512
MULTIPLY (long)	VMDS	QST	VE	A SP	J U EU EO		IM VB R*	A492
MULTIPLY (short to long)	VME	VST	VE	A SP	J U EU EO		IM VB R*	A402
MULTIPLY (short to long)	VMEQ	QV	VE	SP	J U EU EO		IM VB	A582
MULTIPLY (short to long)	VMER	VV	VE	SP	J U EU EO		IM VB	A502
MULTIPLY (short to long)	VMES	QST	VE	A SP	J U EU EO		IM VB R*	A482
MULTIPLY AND ACCUMULATE (long)	VMCD	VST	VE	A SP	J U EU EO LS		IM VB R*	A416
MULTIPLY AND ACCUMULATE (long)	VMCDR	VV	VE	SP	J U EU EO LS		IM VB	A516
MULTIPLY AND ACCUMULATE (s to 1)	VMCE	VST	VE	A SP	J U EU EO LS		IM VB R*	A406
MULTIPLY AND ACCUMULATE (s to 1)	VMCER	VV	VE	SP	J U EU EO LS		IM VB	A506
MULTIPLY AND ADD (long)	VMAD	VST	VE	A SP	J U EU EO LS		IM VB R*	A414
MULTIPLY AND ADD (long)	VMADQ	QV	VE	SP	J U EU EO LS		IM VB	A594
MULTIPLY AND ADD (long)	VMADS	QST	VE	A SP	J U EU EO LS		IM VB R*	A494
MULTIPLY AND ADD (short to long)	VMAE	VST	VE	A SP	J U EU EO LS		IM VB R*	A404
MULTIPLY AND ADD (short to long)	VMAEQ	QV	VE	SP	J U EU EO LS		IM VB	A584
MULTIPLY AND ADD (short to long)	VMAES	QST	VE	A SP	J U EU EO LS		IM VB R*	A484
MULTIPLY AND SUBTRACT (long)	VMSD	VST	VE	A SP	J U EU EO LS		IM VB R*	A415
MULTIPLY AND SUBTRACT (long)	VMSDQ	QV	VE	SP	J U EU EO LS		IM VB	A595
MULTIPLY AND SUBTRACT (long)	VMSDS	QST	VE	A SP	J U EU EO LS		IM VB R*	A495
MULTIPLY AND SUBTRACT (s to 1)	VMSE	VST	VE	A SP	J U EU EO LS		IM VB R*	A405
MULTIPLY AND SUBTRACT (s to 1)	VMSEQ	QV	VE	SP	J U EU EO LS		IM VB	A585
MULTIPLY AND SUBTRACT (s to 1)	VMSES	QST	VE	A SP	J U EU EO LS		IM VB R*	A485

Figure B-1 (Part 3 of 4). Instructions Arranged by Name

Name	Mnemonic	Characteristics							Op Code				
OR	VO	VST	VE	A	SP		IM	VB	R*	A425			
OR	VOQ	QV	VE				IM	VB		A5A5			
OR	VOR	VV	VE				IM	VB		A525			
OR	VOS	QST	VE	A	SP		IM	VB	R*	A4A5			
OR TO VMR	VOVM	VS	VE	A			NC		R*	A685			
RESTORE VAC	VACRS	S	VE	A	SP	P	NO			A6CB			
RESTORE VMR	VMRRS	S	VE	A			NZ			A6C3			
RESTORE VR	VRRS	RRE	C	VE	A	SP	IZ	VU	R*	A648			
RESTORE VSR	VSRRS	S	VE	A	SP	2	IZ	VB		A6C2			
SAVE CHANGED VR	VR SVC	RRE	C	VE	A	SP	IZ	VH	R*	ST A649			
SAVE VAC	VACSV	S	VE	A	SP	P	NO		ST	A6CA			
SAVE VMR	VMRSV	S	VE	A			NZ		ST	A6C1			
SAVE VR	VRSV	RRE	C	VE	A	SP	IZ		R*	ST A64A			
SAVE VSR	VSR SV	S	VE	A	SP	2	NO		ST	A6C0			
SET VECTOR MASK MODE	VSVMM	S	VE				NO			A6C6			
SHIFT LEFT SINGLE LOGICAL	VSLL	RSE	VE				IM	VB		E425			
SHIFT RIGHT SINGLE LOGICAL	VSRL	RSE	VE				IM	VB		E424			
STORE (binary) ¹	VST	VST	VE	A	SP		IC		R*	ST A40D			
STORE (long)	VSTD	VST	VE	A	SP		IC		R*	ST A41D			
STORE (short)	VSTE	VST	VE	A	SP		IC		R*	ST A40D			
STORE COMPRESSED (binary) ¹	VSTK	VST	VE	A	SP		IC		R*	ST A40F			
STORE COMPRESSED (long)	VSTKD	VST	VE	A	SP		IC		R*	ST A41F			
STORE COMPRESSED (short)	VSTKE	VST	VE	A	SP		IC		R*	ST A40F			
STORE HALFWORD	VSTH	VST	VE	A	SP		IC		R*	ST A42D			
STORE INDIRECT (binary) ¹	VSTI	RSE	VE	A	SP		IC		ST	E401			
STORE INDIRECT (long)	VSTID	RSE	VE	A	SP		IC		ST	E411			
STORE INDIRECT (short)	VSTIE	RSE	VE	A	SP		IC		ST	E401			
STORE MATCHED (binary) ¹	VSTM	VST	VE	A	SP		IC		R*	ST A40E			
STORE MATCHED (long)	VSTMD	VST	VE	A	SP		IC		R*	ST A41E			
STORE MATCHED (short)	VSTME	VST	VE	A	SP		IC		R*	ST A40E			
STORE VECTOR PARAMETERS	VSTVP	S	VE	A	SP		NO		ST	A6C8			
STORE VMR	VSTVM	VS	VE	A			NC		R*	ST A682			
SUBTRACT (binary)	VS	VST	VE	A	SP	J	IF	IM	VB	R*	A421		
SUBTRACT (binary)	VSQ	QV	VE			J	IF	IM	VB		A5A1		
SUBTRACT (binary)	VSR	VV	VE			J	IF	IM	VB		A521		
SUBTRACT (binary)	VSS	QST	VE	A	SP	J	IF	IM	VB	R*	A4A1		
SUBTRACT (long)	VSD	VST	VE	A	SP	J	EU	EO	LS	IM	VB	R*	A411
SUBTRACT (long)	VSDQ	QV	VE		SP	J	EU	EO	LS	IM	VB		A591
SUBTRACT (long)	VSDR	VV	VE		SP	J	EU	EO	LS	IM	VB		A511
SUBTRACT (long)	VSDS	QST	VE	A	SP	J	EU	EO	LS	IM	VB	R*	A491
SUBTRACT (short)	VSE	VST	VE	A	SP	J	EU	EO	LS	IM	VB	R*	A401
SUBTRACT (short)	VSEQ	QV	VE		SP	J	EU	EO	LS	IM	VB		A581
SUBTRACT (short)	VSER	VV	VE			J	EU	EO	LS	IM	VB		A501
SUBTRACT (short)	VSES	QST	VE	A	SP	J	EU	EO	LS	IM	VB	R*	A481
SUM PARTIAL SUMS (long)	VSPSD	VR	VE		SP	J	EU	EO	LS	IP			A61A
TEST VMR	VTVM	RRE	C	VE			NC						A640
ZERO PARTIAL SUMS (long)	VZPSD	VR	VE		SP		IP	VB					A61B

Figure B-1 (Part 4 of 4). Instructions Arranged by Name

Mnemonic	Name	Characteristics										Op Code		
VA	ADD (binary)	VST	VE	A	SP	J		IF	IM	VB	R*	A420		
VACD	ACCUMULATE (long)	VST	VE	A	SP	J	EU	EO	LS	IM	VB	R*	A417	
VACDR	ACCUMULATE (long)	VV	VE		SP	J	EU	EO	LS	IM	VB		A517	
VACE	ACCUMULATE (short to long)	VST	VE	A	SP	J	EU	EO	LS	IM	VB	R*	A407	
VACER	ACCUMULATE (short to long)	VV	VE		SP	J	EU	EO	LS	IM	VB		A507	
VACRS	RESTORE VAC	S	VE	A	SP	P				NO			A6CB	
VACSV	SAVE VAC	S	VE	A	SP	P				NO	ST		A6CA	
VAD	ADD (long)	VST	VE	A	SP	J	EU	EO	LS	IM	VB	R*	A410	
VADQ	ADD (long)	QV	VE		SP	J	EU	EO	LS	IM	VB		A590	
VADR	ADD (long)	VV	VE		SP	J	EU	EO	LS	IM	VB		A510	
VADS	ADD (long)	QST	VE	A	SP	J	EU	EO	LS	IM	VB	R*	A490	
VAE	ADD (short)	VST	VE	A	SP	J	EU	EO	LS	IM	VB	R*	A400	
VAEQ	ADD (short)	QV	VE		SP	J	EU	EO	LS	IM	VB		A580	
VAER	ADD (short)	VV	VE			J	EU	EO	LS	IM	VB		A500	
VAES	ADD (short)	QST	VE	A	SP	J	EU	EO	LS	IM	VB	R*	A480	
VAQ	ADD (binary)	QV	VE			J	IF		IM	VB			A5A0	
VAR	ADD (binary)	VV	VE			J	IF		IM	VB			A520	
VAS	ADD (binary)	QST	VE	A	SP	J	IF		IM	VB	R*		A4A0	
VC	COMPARE (binary)	VST	VE	A	SP					IC	R*		A428	
VCD	COMPARE (long)	VST	VE	A	SP					IC	R*		A418	
VCDQ	COMPARE (long)	QV	VE		SP					IC			A598	
VCDR	COMPARE (long)	VV	VE		SP					IC			A518	
VCDS	COMPARE (long)	QST	VE	A	SP					IC	R*		A498	
VCE	COMPARE (short)	VST	VE	A	SP					IC	R*		A408	
VCEQ	COMPARE (short)	QV	VE		SP					IC			A588	
VCER	COMPARE (short)	VV	VE							IC			A508	
VCES	COMPARE (short)	QST	VE	A	SP					IC	R*		A488	
VCOVM	COUNT ONES IN VMR	RRE	C	VE						NC	R*		A643	
VCQ	COMPARE (binary)	QV	VE							IC			A5A8	
VCR	COMPARE (binary)	VV	VE							IC			A528	
VCS	COMPARE (binary)	QST	VE	A	SP					IC	R*		A4A8	
VCVM	COMPLEMENT VMR	RRE	VE							NC			A641	
VCZVM	COUNT LEFT ZEROS IN VMR	RRE	C	VE						NC	R*		A642	
VDD	DIVIDE (long)	VST	VE	A	SP	J	U	EU	EO	FK	IM	VB	R*	A413
VDDQ	DIVIDE (long)	QV	VE		SP	J	U	EU	EO	FK	IM	VB		A593
VDDR	DIVIDE (long)	VV	VE		SP	J	U	EU	EO	FK	IM	VB		A513
VDDS	DIVIDE (long)	QST	VE	A	SP	J	U	EU	EO	FK	IM	VB	R*	A493
VDE	DIVIDE (short)	VST	VE	A	SP	J	U	EU	EO	FK	IM	VB	R*	A403
VDEQ	DIVIDE (short)	QV	VE		SP	J	U	EU	EO	FK	IM	VB		A583
VDER	DIVIDE (short)	VV	VE			J	U	EU	EO	FK	IM	VB		A503
VDES	DIVIDE (short)	QST	VE	A	SP	J	U	EU	EO	FK	IM	VB	R*	A483
VL	LOAD (binary) ¹	VST	VE	A	SP					IC	VB	R*	A409	
VLBIX	LOAD BIT INDEX	RSE	C	VE	A	SP				IG	VB	R*	E428	
VLCDR	LOAD COMPLEMENT (long)	VV	VE		SP					IM	VB		A552	
VLCER	LOAD COMPLEMENT (short)	VV	VE							IM	VB		A542	

Figure B-2 (Part 1 of 4). Instructions Arranged by Mnemonic

Mnemonic	Name	Characteristics							Op Code	
VLCR	LOAD COMPLEMENT (binary)	VV	VE			J	IF	IM VB	R*	A562
VLCVM	LOAD VMR COMPLEMENT	VS	VE	A				NC	R*	A681
VLD	LOAD (long)	VST	VE	A	SP			IC VB	R*	A419
VLDQ	LOAD (long)	QV	VE		SP			IC VB		A599
VLDR	LOAD (long)	VV	VE		SP			IC VB		A519
VLE	LOAD (short)	VST	VE	A	SP			IC VB	R*	A409
VLEL	LOAD ELEMENT (binary)	VR	VE		SP			N1 VB		A628
VLELD	LOAD ELEMENT (long)	VR	VE		SP			N1 VB		A618
VLELE	LOAD ELEMENT (short)	VR	VE		SP			N1 VB		A608
VLEQ	LOAD (short)	QV	VE		SP			IC VB		A589
VLER	LOAD (short)	VV	VE					IC VB		A509
VLH	LOAD HALFWORD	VST	VE	A	SP			IC VB	R*	A429
VLI	LOAD INDIRECT (binary) ¹	RSE	VE	A	SP			IC VB		E400
VLID	LOAD INDIRECT (long)	RSE	VE	A	SP			IC VB		E410
VLIE	LOAD INDIRECT (short)	RSE	VE	A	SP			IC VB		E400
VLINT	LOAD INTEGER VECTOR	VST	VE		SP			IC VB	R*	A42A
VLM	LOAD MATCHED (binary) ¹	VST	VE	A	SP			IC VB	R*	A40A
VLMD	LOAD MATCHED (long)	VST	VE	A	SP			IC VB	R*	A41A
VLMDQ	LOAD MATCHED (long)	QV	VE		SP			IC VB		A59A
VLMDR	LOAD MATCHED (long)	VV	VE		SP			IC VB		A51A
VLME	LOAD MATCHED (short)	VST	VE	A	SP			IC VB	R*	A40A
VLMEQ	LOAD MATCHED (short)	QV	VE		SP			IC VB		A58A
VLMER	LOAD MATCHED (short)	VV	VE					IC VB		A50A
VLMQ	LOAD MATCHED (binary)	QV	VE					IC VB		A5AA
VLMR	LOAD MATCHED (binary) ¹	VV	VE					IC VB		A50A
VLNDR	LOAD NEGATIVE (long)	VV	VE		SP			IM VB		A551
VLNER	LOAD NEGATIVE (short)	VV	VE					IM VB		A541
VLNR	LOAD NEGATIVE (binary)	VV	VE					IM VB		A561
VLPDR	LOAD POSITIVE (long)	VV	VE		SP			IM VB		A550
VLPER	LOAD POSITIVE (short)	VV	VE					IM VB		A540
VLPR	LOAD POSITIVE (binary)	VV	VE			J	IF	IM VB		A560
VLQ	LOAD (binary)	QV	VE					IC VB		A5A9
VLR	LOAD (binary) ¹	VV	VE					IC VB		A509
VLVCA	LOAD VCT FROM ADDRESS	S	C	VE				NO		A6C4
VLVCU	LOAD VCT AND UPDATE	RRE	C	VE				NO	R*	A645
VLVM	LOAD VMR	VS	VE	A				NC	R*	A680
VLY	LOAD EXPANDED (binary) ¹	VST	VE	A	SP			IC VB	R*	A40B
VLYD	LOAD EXPANDED (long)	VST	VE	A	SP			IC VB	R*	A41B
VLYE	LOAD EXPANDED (short)	VST	VE	A	SP			IC VB	R*	A40B
VLZDR	LOAD ZERO (long)	VV	VE		SP			IC VB		A51B
VLZER	LOAD ZERO (short)	VV	VE					IC VB		A50B
VLZR	LOAD ZERO (binary) ¹	VV	VE					IC VB		A50B
VM	MULTIPLY (binary)	VST	VE	A	SP			IM VB	R*	A422
VMAD	MULTIPLY AND ADD (long)	VST	VE	A	SP	J	U EU EO LS	IM VB	R*	A414
VMADQ	MULTIPLY AND ADD (long)	QV	VE		SP	J	U EU EO LS	IM VB		A594

Figure B-2 (Part 2 of 4). Instructions Arranged by Mnemonic

Mnemonic	Name	Characteristics							Op Code					
VMADS	MULTIPLY AND ADD (long)	QST	VE	A	SP	J	U	EU	EO	LS	IM	VB	R*	A494
VMAE	MULTIPLY AND ADD(short to long)	VST	VE	A	SP	J	U	EU	EO	LS	IM	VB	R*	A404
VMAEQ	MULTIPLY AND ADD(short to long)	QV	VE		SP	J	U	EU	EO	LS	IM	VB		A584
VMAES	MULTIPLY AND ADD(short to long)	QST	VE	A	SP	J	U	EU	EO	LS	IM	VB	R*	A484
VMCD	MULTIPLY AND ACCUMULATE (long)	VST	VE	A	SP	J	U	EU	EO	LS	IM	VB	R*	A416
VMCDR	MULTIPLY AND ACCUMULATE (long)	VV	VE		SP	J	U	EU	EO	LS	IM	VB		A516
VMCE	MULTIPLY AND ACCUMULATE(s to 1)	VST	VE	A	SP	J	U	EU	EO	LS	IM	VB	R*	A406
VMCER	MULTIPLY AND ACCUMULATE(s to 1)	VV	VE		SP	J	U	EU	EO	LS	IM	VB		A506
VMD	MULTIPLY (long)	VST	VE	A	SP	J	U	EU	EO		IM	VB	R*	A412
VMDQ	MULTIPLY (long)	QV	VE		SP	J	U	EU	EO		IM	VB		A592
VMDR	MULTIPLY (long)	VV	VE		SP	J	U	EU	EO		IM	VB		A512
VMDS	MULTIPLY (long)	QST	VE	A	SP	J	U	EU	EO		IM	VB	R*	A492
VME	MULTIPLY (short to long)	VST	VE	A	SP	J	U	EU	EO		IM	VB	R*	A402
VMEQ	MULTIPLY (short to long)	QV	VE		SP	J	U	EU	EO		IM	VB		A582
VMER	MULTIPLY (short to long)	VV	VE		SP	J	U	EU	EO		IM	VB		A502
VMES	MULTIPLY (short to long)	QST	VE	A	SP	J	U	EU	EO		IM	VB	R*	A482
VMNSD	MINIMUM SIGNED (long)	VR	VE		SP						IM		R*	A611
VMNSE	MINIMUM SIGNED (short)	VR	VE		SP						IM		R*	A601
VMQ	MULTIPLY (binary)	QV	VE		SP						IM	VB		A5A2
VMR	MULTIPLY (binary)	VV	VE		SP						IM	VB		A522
VMRRS	RESTORE VMR	S	VE	A							NZ			A6C3
VMRSV	SAVE VMR	S	VE	A							NZ		ST	A6C1
VMS	MULTIPLY (binary)	QST	VE	A	SP						IM	VB	R*	A4A2
VMSD	MULTIPLY AND SUBTRACT (long)	VST	VE	A	SP	J	U	EU	EO	LS	IM	VB	R*	A415
VMSDQ	MULTIPLY AND SUBTRACT (long)	QV	VE		SP	J	U	EU	EO	LS	IM	VB		A595
VMSDS	MULTIPLY AND SUBTRACT (long)	QST	VE	A	SP	J	U	EU	EO	LS	IM	VB	R*	A495
VMSE	MULTIPLY AND SUBTRACT (s to 1)	VST	VE	A	SP	J	U	EU	EO	LS	IM	VB	R*	A405
VMSEQ	MULTIPLY AND SUBTRACT (s to 1)	QV	VE		SP	J	U	EU	EO	LS	IM	VB		A585
VMSES	MULTIPLY AND SUBTRACT (s to 1)	QST	VE	A	SP	J	U	EU	EO	LS	IM	VB	R*	A485
VMXAD	MAXIMUM ABSOLUTE (long)	VR	VE		SP						IM		R*	A612
VMXAE	MAXIMUM ABSOLUTE (short)	VR	VE		SP						IM		R*	A602
VMXSD	MAXIMUM SIGNED (long)	VR	VE		SP						IM		R*	A610
VMXSE	MAXIMUM SIGNED (short)	VR	VE		SP						IM		R*	A600
VN	AND	VST	VE	A	SP						IM	VB	R*	A424
VNQ	AND	QV	VE								IM	VB		A5A4
VNR	AND	VV	VE								IM	VB		A524
VNS	AND	QST	VE	A	SP						IM	VB	R*	A4A4
VNVM	AND TO VMR	VS	VE	A							NC		R*	A684
VO	OR	VST	VE	A	SP						IM	VB	R*	A425
VOQ	OR	QV	VE								IM	VB		A5A5
VOR	OR	VV	VE								IM	VB		A525
VOS	OR	QST	VE	A	SP						IM	VB	R*	A4A5
VOVM	OR TO VMR	VS	VE	A							NC		R*	A685
VRCL	CLEAR VR	S	VE								IZ	VB		A6C5
VRRS	RESTORE VR	RRE	C	VE	A	SP	2				IZ	VU	R*	A648

Figure B-2 (Part 3 of 4). Instructions Arranged by Mnemonic

Mnemonic	Name	Characteristics						Op Code		
VRSV	SAVE VR	RRE	C	VE	A	SP	IZ	R*	ST	A64A
VRSVC	SAVE CHANGED VR	RRE	C	VE	A	SP	P IZ VH	R*	ST	A649
VS	SUBTRACT (binary)	VST		VE	A	SP	J IF IM VB	R*		A421
VSD	SUBTRACT (long)	VST		VE	A	SP	J EU EO LS IM VB	R*		A411
VSDQ	SUBTRACT (long)	QV		VE		SP	J EU EO LS IM VB			A591
VSDR	SUBTRACT (long)	VV		VE		SP	J EU EO LS IM VB			A511
VSDS	SUBTRACT (long)	QST		VE	A	SP	J EU EO LS IM VB	R*		A491
VSE	SUBTRACT (short)	VST		VE	A	SP	J EU EO LS IM VB	R*		A401
VSEQ	SUBTRACT (short)	QV		VE		SP	J EU EO LS IM VB			A581
VSER	SUBTRACT (short)	VV		VE			J EU EO LS IM VB			A501
VSES	SUBTRACT (short)	QST		VE	A	SP	J EU EO LS IM VB	R*		A481
VSL	SHIFT LEFT SINGLE LOGICAL	RSE		VE			IM VB			E425
VSPSD	SUM PARTIAL SUMS (long)	VR		VE		SP	J EU EO LS IP			A61A
VSQ	SUBTRACT (binary)	QV		VE			J IF IM VB			A5A1
VSR	SUBTRACT (binary)	VV		VE			J IF IM VB			A521
VSRL	SHIFT RIGHT SINGLE LOGICAL	RSE		VE			IM VB			E424
VSRRS	RESTORE VSR	S		VE	A	SP	² IZ VB			A6C2
VSRSV	SAVE VSR	S		VE	A	SP	² NO		ST	A6C0
VSS	SUBTRACT (binary)	QST		VE	A	SP	J IF IM VB	R*		A4A1
VST	STORE (binary) ¹	VST		VE	A	SP	J IF IC	R*	ST	A40D
VSTD	STORE (long)	VST		VE	A	SP	IC	R*	ST	A41D
VSTE	STORE (short)	VST		VE	A	SP	IC	R*	ST	A40D
VSTH	STORE HALFWORD	VST		VE	A	SP	IC	R*	ST	A42D
VSTI	STORE INDIRECT (binary) ¹	RSE		VE	A	SP	IC		ST	E401
VSTID	STORE INDIRECT (long)	RSE		VE	A	SP	IC		ST	E411
VSTIE	STORE INDIRECT (short)	RSE		VE	A	SP	IC		ST	E401
VSTK	STORE COMPRESSED (binary) ¹	VST		VE	A	SP	IC	R*	ST	A40F
VSTKD	STORE COMPRESSED (long)	VST		VE	A	SP	IC	R*	ST	A41F
VSTKE	STORE COMPRESSED (short)	VST		VE	A	SP	IC	R*	ST	A40F
VSTM	STORE MATCHED (binary) ¹	VST		VE	A	SP	IC	R*	ST	A40E
VSTMD	STORE MATCHED (long)	VST		VE	A	SP	IC	R*	ST	A41E
VSTME	STORE MATCHED (short)	VST		VE	A	SP	IC	R*	ST	A40E
VSTVM	STORE VMR	VS		VE	A		NC	R*	ST	A682
VSTVP	STORE VECTOR PARAMETERS	S		VE	A	SP	NO		ST	A6C8
VSVMM	SET VECTOR MASK MODE	S		VE			NO			A6C6
VTVM	TEST VMR	RRE	C	VE			NC			A640
VX	EXCLUSIVE OR	VST		VE	A	SP	IM VB	R*		A426
VXEL	EXTRACT ELEMENT (binary)	VR		VE		SP	N1	R*		A629
VXELD	EXTRACT ELEMENT (long)	VR		VE		SP	N1			A619
VXELE	EXTRACT ELEMENT (short)	VR		VE		SP	N1			A609
VXQ	EXCLUSIVE OR	QV		VE			IM VB			A5A6
VXR	EXCLUSIVE OR	VV		VE			IM VB			A526
VXS	EXCLUSIVE OR	QST		VE	A	SP	IM VB	R*		A4A6
VXVC	EXTRACT VCT	RRE		VE			NO	R*		A644
VXVM	EXCLUSIVE OR TO VMR	VS		VE	A		NC	R*		A686
VXVMM	EXTRACT VECTOR MASK MODE	RRE		VE			NO	R*		A646
VZPSD	ZERO PARTIAL SUMS (long)	VR		VE		SP	IP VB			A61B

Figure B-2 (Part 4 of 4). Instructions Arranged by Mnemonic

Op Code	Name	Mne- monic	<i>initial</i> Characteristics									
A400	ADD (short)	VAE	VST	VE	A SP	J	EU	EO	LS	IM	VB	R*
A401	SUBTRACT (short)	VSE	VST	VE	A SP	J	EU	EO	LS	IM	VB	R*
A402	MULTIPLY (short to long)	VME	VST	VE	A SP	J U	EU	EO		IM	VB	R*
A403	DIVIDE (short)	VDE	VST	VE	A SP	J U	EU	EO	FK	IM	VB	R*
A404	MULTIPLY AND ADD(short to long)	VMAE	VST	VE	A SP	J U	EU	EO	LS	IM	VB	R*
A405	MULTIPLY AND SUBTRACT (s to 1)	VMSE	VST	VE	A SP	J U	EU	EO	LS	IM	VB	R*
A406	MULTIPLY AND ACCUMULATE(s to 1)	VMCE	VST	VE	A SP	J U	EU	EO	LS	IM	VB	R*
A407	ACCUMULATE (short to long)	VACE	VST	VE	A SP	J	EU	EO	LS	IM	VB	R*
A408	COMPARE (short)	VCE	VST	VE	A SP					IC		R*
A409	LOAD (binary) ¹	VL	VST	VE	A SP					IC	VB	R*
A409	LOAD (short)	VLE	VST	VE	A SP					IC	VB	R*
A40A	LOAD MATCHED (binary) ¹	VLM	VST	VE	A SP					IC	VB	R*
A40A	LOAD MATCHED (short)	VLME	VST	VE	A SP					IC	VB	R*
A40B	LOAD EXPANDED (binary) ¹	VLY	VST	VE	A SP					IC	VB	R*
A40B	LOAD EXPANDED (short)	VLYE	VST	VE	A SP					IC	VB	R*
A40D	STORE (binary) ¹	VST	VST	VE	A SP					IC		R* ST
A40D	STORE (short)	VSTE	VST	VE	A SP					IC		R* ST
A40E	STORE MATCHED (binary) ¹	VSTM	VST	VE	A SP					IC		R* ST
A40E	STORE MATCHED (short)	VSTME	VST	VE	A SP					IC		R* ST
A40F	STORE COMPRESSED (binary) ¹	VSTK	VST	VE	A SP					IC		R* ST
A40F	STORE COMPRESSED (short)	VSTKE	VST	VE	A SP					IC		R* ST
A410	ADD (long)	VAD	VST	VE	A SP	J	EU	EO	LS	IM	VB	R*
A411	SUBTRACT (long)	VSD	VST	VE	A SP	J	EU	EO	LS	IM	VB	R*
A412	MULTIPLY (long)	VMD	VST	VE	A SP	J U	EU	EO		IM	VB	R*
A413	DIVIDE (long)	VDD	VST	VE	A SP	J U	EU	EO	FK	IM	VB	R*
A414	MULTIPLY AND ADD (long)	VMAD	VST	VE	A SP	J U	EU	EO	LS	IM	VB	R*
A415	MULTIPLY AND SUBTRACT (long)	VMSD	VST	VE	A SP	J U	EU	EO	LS	IM	VB	R*
A416	MULTIPLY AND ACCUMULATE (long)	VMCD	VST	VE	A SP	J U	EU	EO	LS	IM	VB	R*
A417	ACCUMULATE (long)	VACD	VST	VE	A SP	J	EU	EO	LS	IM	VB	R*
A418	COMPARE (long)	VCD	VST	VE	A SP					IC		R*
A419	LOAD (long)	VLD	VST	VE	A SP					IC	VB	R*
A41A	LOAD MATCHED (long)	VLMD	VST	VE	A SP					IC	VB	R*
A41B	LOAD EXPANDED (long)	VLYD	VST	VE	A SP					IC	VB	R*
A41D	STORE (long)	VSTD	VST	VE	A SP					IC		R* ST
A41E	STORE MATCHED (long)	VSTMD	VST	VE	A SP					IC		R* ST
A41F	STORE COMPRESSED (long)	VSTKD	VST	VE	A SP					IC		R* ST
A420	ADD (binary)	VA	VST	VE	A SP	J		IF		IM	VB	R*
A421	SUBTRACT (binary)	VS	VST	VE	A SP	J		IF		IM	VB	R*
A422	MULTIPLY (binary)	VM	VST	VE	A SP					IM	VB	R*
A424	AND	VN	VST	VE	A SP					IM	VB	R*
A425	OR	VO	VST	VE	A SP					IM	VB	R*
A426	EXCLUSIVE OR	VX	VST	VE	A SP					IM	VB	R*
A428	COMPARE (binary)	VC	VST	VE	A SP					IC		R*
A429	LOAD HALFWORD	VLH	VST	VE	A SP					IC	VB	R*
A42A	LOAD INTEGER VECTOR	VLINT	VST	VE	SP					IC	VB	R*

Figure B-3 (Part 1 of 4). Instructions Arranged by Op Code

Op Code	Name	Mne-monic	Characteristics							
A42D	STORE HALFWORD	VSTH	VST	VE	A	SP		IC	R*	ST
A480	ADD (short)	VAES	QST	VE	A	SP	J	EU EO LS IM VB	R*	
A481	SUBTRACT (short)	VSES	QST	VE	A	SP	J	EU EO LS IM VB	R*	
A482	MULTIPLY (short to long)	VMES	QST	VE	A	SP	J U	EU EO IM VB	R*	
A483	DIVIDE (short)	VDES	QST	VE	A	SP	J U	EU EO FK IM VB	R*	
A484	MULTIPLY AND ADD(short to long)	VMAES	QST	VE	A	SP	J U	EU EO LS IM VB	R*	
A485	MULTIPLY AND SUBTRACT (s to l)	VMSES	QST	VE	A	SP	J U	EU EO LS IM VB	R*	
A488	COMPARE (short)	VCES	QST	VE	A	SP		IC	R*	
A490	ADD (long)	VADS	QST	VE	A	SP	J	EU EO LS IM VB	R*	
A491	SUBTRACT (long)	VSDS	QST	VE	A	SP	J	EU EO LS IM VB	R*	
A492	MULTIPLY (long)	VMDS	QST	VE	A	SP	J U	EU EO IM VB	R*	
A493	DIVIDE (long)	VDDS	QST	VE	A	SP	J U	EU EO FK IM VB	R*	
A494	MULTIPLY AND ADD (long)	VMADS	QST	VE	A	SP	J U	EU EO LS IM VB	R*	
A495	MULTIPLY AND SUBTRACT (long)	VMSDS	QST	VE	A	SP	J U	EU EO LS IM VB	R*	
A498	COMPARE (long)	VCDS	QST	VE	A	SP		IC	R*	
A4A0	ADD (binary)	VAS	QST	VE	A	SP	J	IF IM VB	R*	
A4A1	SUBTRACT (binary)	VSS	QST	VE	A	SP	J	IF IM VB	R*	
A4A2	MULTIPLY (binary)	VMS	QST	VE	A	SP		IM VB	R*	
A4A4	AND	VNS	QST	VE	A	SP		IM VB	R*	
A4A5	OR	VOS	QST	VE	A	SP		IM VB	R*	
A4A6	EXCLUSIVE OR	VXS	QST	VE	A	SP		IM VB	R*	
A4A8	COMPARE (binary)	VCS	QST	VE	A	SP		IC	R*	
A500	ADD (short)	VAER	VV	VE			J	EU EO LS IM VB		
A501	SUBTRACT (short)	VSER	VV	VE			J	EU EO LS IM VB		
A502	MULTIPLY (short to long)	VMER	VV	VE		SP	J U	EU EO IM VB		
A503	DIVIDE (short)	VDER	VV	VE			J U	EU EO FK IM VB		
A506	MULTIPLY AND ACCUMULATE(s to 1)	VMCER	VV	VE		SP	J U	EU EO LS IM VB		
A507	ACCUMULATE (short to long)	VACER	VV	VE		SP	J	EU EO LS IM VB		
A508	COMPARE (short)	VCER	VV	VE				IC		
A509	LOAD (binary) ¹	VLR	VV	VE				IC VB		
A509	LOAD (short)	VLER	VV	VE				IC VB		
A50A	LOAD MATCHED (binary) ¹	VLMR	VV	VE				IC VB		
A50A	LOAD MATCHED (short)	VLMER	VV	VE				IC VB		
A50B	LOAD ZERO (binary) ¹	VLZR	VV	VE				IC VB		
A50B	LOAD ZERO (short)	VLZER	VV	VE				IC VB		
A510	ADD (long)	VADR	VV	VE		SP	J	EU EO LS IM VB		
A511	SUBTRACT (long)	VSDR	VV	VE		SP	J	EU EO LS IM VB		
A512	MULTIPLY (long)	VMDR	VV	VE		SP	J U	EU EO IM VB		
A513	DIVIDE (long)	VDDR	VV	VE		SP	J U	EU EO FK IM VB		
A516	MULTIPLY AND ACCUMULATE (long)	VMCDR	VV	VE		SP	J U	EU EO LS IM VB		
A517	ACCUMULATE (long)	VACDR	VV	VE		SP	J	EU EO LS IM VB		
A518	COMPARE (long)	VCDR	VV	VE		SP		IC		
A519	LOAD (long)	VLDR	VV	VE		SP		IC VB		
A51A	LOAD MATCHED (long)	VLMDR	VV	VE		SP		IC VB		
A51B	LOAD ZERO (long)	VLZDR	VV	VE		SP		IC VB		

Figure B-3 (Part 2 of 4). Instructions Arranged by Op Code

Op Code	Name	Mnemonic	Characteristics						
A520	ADD (binary)	VAR	VV	VE		J	IF	IM	VB
A521	SUBTRACT (binary)	VSR	VV	VE		J	IF	IM	VB
A522	MULTIPLY (binary)	VMR	VV	VE	SP			IM	VB
A524	AND	VNR	VV	VE				IM	VB
A525	OR	VOR	VV	VE				IM	VB
A526	EXCLUSIVE OR	VXR	VV	VE				IM	VB
A528	COMPARE (binary)	VCR	VV	VE				IC	
A540	LOAD POSITIVE (short)	VLPER	VV	VE				IM	VB
A541	LOAD NEGATIVE (short)	VLNER	VV	VE				IM	VB
A542	LOAD COMPLEMENT (short)	VLGER	VV	VE				IM	VB
A550	LOAD POSITIVE (long)	VLPDR	VV	VE	SP			IM	VB
A551	LOAD NEGATIVE (long)	VLNDR	VV	VE	SP			IM	VB
A552	LOAD COMPLEMENT (long)	VLCDR	VV	VE	SP			IM	VB
A560	LOAD POSITIVE (binary)	VLPR	VV	VE		J	IF	IM	VB
A561	LOAD NEGATIVE (binary)	VLNR	VV	VE				IM	VB
A562	LOAD COMPLEMENT (binary)	VLGR	VV	VE		J	IF	IM	VB
A580	ADD (short)	VAEQ	QV	VE	SP	J	EU EO LS	IM	VB
A581	SUBTRACT (short)	VSEQ	QV	VE	SP	J	EU EO LS	IM	VB
A582	MULTIPLY (short to long)	VMEQ	QV	VE	SP	J U	EU EO	IM	VB
A583	DIVIDE (short)	VDEQ	QV	VE	SP	J U	EU EO FK	IM	VB
A584	MULTIPLY AND ADD (short to long)	VMAEQ	QV	VE	SP	J U	EU EO LS	IM	VB
A585	MULTIPLY AND SUBTRACT (s to l)	VMSEQ	QV	VE	SP	J U	EU EO LS	IM	VB
A588	COMPARE (short)	VCEQ	QV	VE	SP			IC	
A589	LOAD (short)	VLEQ	QV	VE	SP			IC	VB
A58A	LOAD MATCHED (short)	VLMEQ	QV	VE	SP			IC	VB
A590	ADD (long)	VADQ	QV	VE	SP	J	EU EO LS	IM	VB
A591	SUBTRACT (long)	VSDQ	QV	VE	SP	J	EU EO LS	IM	VB
A592	MULTIPLY (long)	VMDQ	QV	VE	SP	J U	EU EO	IM	VB
A593	DIVIDE (long)	VDDQ	QV	VE	SP	J U	EU EO FK	IM	VB
A594	MULTIPLY AND ADD (long)	VMADQ	QV	VE	SP	J U	EU EO LS	IM	VB
A595	MULTIPLY AND SUBTRACT (long)	VMSDQ	QV	VE	SP	J U	EU EO LS	IM	VB
A598	COMPARE (long)	VCDQ	QV	VE	SP			IC	
A599	LOAD (long)	VLDQ	QV	VE	SP			IC	VB
A59A	LOAD MATCHED (long)	VLMDQ	QV	VE	SP			IC	VB
A5A0	ADD (binary)	VAQ	QV	VE		J	IF	IM	VB
A5A1	SUBTRACT (binary)	VSQ	QV	VE		J	IF	IM	VB
A5A2	MULTIPLY (binary)	VMQ	QV	VE	SP			IM	VB
A5A4	AND	VNQ	QV	VE				IM	VB
A5A5	OR	VOQ	QV	VE				IM	VB
A5A6	EXCLUSIVE OR	VXQ	QV	VE				IM	VB
A5A8	COMPARE (binary)	VCQ	QV	VE				IC	
A5A9	LOAD (binary)	VLQ	QV	VE				IC	VB
A5AA	LOAD MATCHED (binary)	VLMQ	QV	VE				IC	VB
A600	MAXIMUM SIGNED (short)	VMXSE	VR	VE	SP			IM	R*
A601	MINIMUM SIGNED (short)	VMNSE	VR	VE	SP			IM	R*

Figure B-3 (Part 3 of 4). Instructions Arranged by Op Code

Op Code	Name	Mne- monic	Characteristics					
A602	MAXIMUM ABSOLUTE (short)	VMXAE	VR	VE	SP		IM	R*
A608	LOAD ELEMENT (short)	VLELE	VR	VE	SP		N1 VB	
A609	EXTRACT ELEMENT (short)	VXELE	VR	VE	SP		N1	
A610	MAXIMUM SIGNED (long)	VMXSD	VR	VE	SP		IM	R*
A611	MINIMUM SIGNED (long)	VMNSD	VR	VE	SP		IM	R*
A612	MAXIMUM ABSOLUTE (long)	VMXAD	VR	VE	SP		IM	R*
A618	LOAD ELEMENT (long)	VLELD	VR	VE	SP		N1 VB	
A619	EXTRACT ELEMENT (long)	VXELE	VR	VE	SP		N1	
A61A	SUM PARTIAL SUMS (long)	VSPSD	VR	VE	SP	J	EU EO LS IP	
A61B	ZERO PARTIAL SUMS (long)	VZPSD	VR	VE	SP		IP VB	
A628	LOAD ELEMENT (binary)	VLEL	VR	VE	SP		N1 VB	R*
A629	EXTRACT ELEMENT (binary)	VXEL	VR	VE	SP		N1	
A640	TEST VMR	VTVM	RRE	C	VE		NC	
A641	COMPLEMENT VMR	VCVM	RRE		VE		NC	
A642	COUNT LEFT ZEROS IN VMR	VCZVM	RRE	C	VE		NC	R*
A643	COUNT ONES IN VMR	VCVOM	RRE	C	VE		NC	R*
A644	EXTRACT VCT	VXVC	RRE		VE		NO	R*
A645	LOAD VCT AND UPDATE	VLVCU	RRE	C	VE		NO	R*
A646	EXTRACT VECTOR MASK MODE	VXVMM	RRE		VE		NO	R*
A648	RESTORE VR	VRRS	RRE	C	VE	A SP	IZ VU	R*
A649	SAVE CHANGED VR	VRSVC	RRE	C	VE	A SP	IZ VH	R* ST
A64A	SAVE VR	VRSV	RRE	C	VE	A SP	IZ	R* ST
A680	LOAD VMR	VLVM	VS		VE	A	NC	R*
A681	LOAD VMR COMPLEMENT	VLVCM	VS		VE	A	NC	R*
A682	STORE VMR	VSTVM	VS		VE	A	NC	R* ST
A684	AND TO VMR	VNVM	VS		VE	A	NC	R*
A685	OR TO VMR	VOVM	VS		VE	A	NC	R*
A686	EXCLUSIVE OR TO VMR	VXVM	VS		VE	A	NC	R*
A6C0	SAVE VSR	VSRSV	S		VE	A SP	NO	ST
A6C1	SAVE VMR	VMRSV	S		VE	A	NZ	ST
A6C2	RESTORE VSR	VSRRS	S		VE	A SP	IZ VB	
A6C3	RESTORE VMR	VMRRS	S		VE	A	NZ	
A6C4	LOAD VCT FROM ADDRESS	VLVCA	S	C	VE		NO	
A6C5	CLEAR VR	VRCL	S		VE		IZ VB	
A6C6	SET VECTOR MASK MODE	VSVM	S		VE		NO	
A6C8	STORE VECTOR PARAMETERS	VSTVP	S		VE	A SP	NO	ST
A6CA	SAVE VAC	VACSV	S		VE	A SP	NO	ST
A6CB	RESTORE VAC	VACRS	S		VE	A SP	NO	
E400	LOAD INDIRECT (binary) ¹	VLI	RSE		VE	A SP	IC VB	
E400	LOAD INDIRECT (short)	VLIE	RSE		VE	A SP	IC VB	
E401	STORE INDIRECT (binary) ¹	VSTI	RSE		VE	A SP	IC	ST
E401	STORE INDIRECT (short)	VSTIE	RSE		VE	A SP	IC	ST
E410	LOAD INDIRECT (long)	VLID	RSE		VE	A SP	IC VB	
E411	STORE INDIRECT (long)	VSTID	RSE		VE	A SP	IC	ST
E424	SHIFT RIGHT SINGLE LOGICAL	VSRL	RSE		VE		IM VB	
E425	SHIFT LEFT SINGLE LOGICAL	VSLL	RSE		VE		IM VB	
E428	LOAD BIT INDEX	VLBIX	RSE	C	VE	A SP	IG VB	R*

Figure B-3 (Part 4 of 4). Instructions Arranged by Op Code

A

access exceptions for vector
 operands 2-25
 access of vectors in storage 2-8
 ACCUMULATE vector instructions 3-2
 active bits and elements 2-3
 activity count for vectors 2-5
 ADD vector instructions 3-3
 examples A-1
 address generation 2-18
 for LOAD INTEGER VECTOR 3-18
 for LOAD/STORE INDIRECT 3-17
 address size 2-6
 address updating 2-9
 in sectioning 2-11
 addressing mode (in 370-XA mode) 2-6
 alignment on storage boundary 2-7
 AND TO VMR vector instruction 3-5
 AND vector instructions 3-4
 architectural mode 2-6
 arithmetic (conditional) 2-12
 examples A-4
 arithmetic exceptions 2-21
 arithmetic partial-completion bit 2-21
 arithmetic vectors 2-7
 availability of vector facility 2-6,
 2-27
 effect of machine check on 2-31

B

binary integers 2-7
 bit count 3-12
 bit index 3-12
 relation of to element number 2-10
 bit vector 2-10
 boundary alignment 2-7

C

change bits 2-4
 in saving and restoring 2-28
 classes of vector instructions 2-13
 CLEAR VR vector instruction 3-5
 clearing of vector registers 2-29
 COMPARE vector instructions 3-6
 examples A-4, A-7
 compatibility of vector programs 1-1
 COMPLEMENT VMR vector instruction 3-7
 completion of unit of operation 2-22
 conceptual sequence of vector
 operations 2-20, 2-30
 conditional vector arithmetic 2-12
 examples A-4, A-7
 configuration of vector facility 2-6

contiguous vectors 2-8
 access exceptions for 2-25
 examples A-1
 control bit in control register 0 2-6
 effect of on machine check 2-31
 conversion
 of bits to element numbers 2-10
 of floating-point vectors A-6
 count
 bit 3-12
 net 2-15
 vector 2-3
 vector-activity 2-5
 COUNT LEFT ZEROS IN VMR vector instruc-
 tion 3-8
 COUNT ONES IN VMR vector
 instruction 3-8

D

damage to vector facility 2-31
 data types 2-7
 DIVIDE vector instructions 3-8
 example A-4

E

element iii
 indirect selection of 2-9
 vector 2-1
 element number 2-1
 relation of to bit index 2-10
 exception-extension code 2-21
 exceptions
 access 2-25
 arithmetic 2-21
 avoidance of A-4
 exponent-overflow 2-21, 2-26
 exponent-underflow 2-21, 2-26
 fixed-point-overflow 2-7, 2-21
 floating-point-divide 2-21, 2-26
 operation 2-6
 significance 2-21
 specification 2-26
 unnormalized-operand 2-21, 2-27
 vector-operation 2-6, 2-27
 EXCLUSIVE OR TO VMR vector
 instruction 3-10
 EXCLUSIVE OR vector instructions 3-9
 exponent-overflow exception 2-21, 2-26
 exponent-underflow exception 2-21, 2-26
 extension code for exceptions 2-21
 EXTRACT ELEMENT vector
 instructions 3-10
 EXTRACT VCT vector instruction 3-11

EXTRACT VECTOR MASK MODE vector instruction 3-11

F

failure of vector facility 2-31
fields in vector-instruction
formats 2-13
fixed-point-overflow exception 2-7,
2-21
floating-point conversion
(examples) A-6
floating-point-divide exception 2-21,
2-26
floating-point numbers 2-7
floating-point register (in vector operations) 2-10
formats of vector instructions 2-13

G

general register (in vector operations) 2-10

I

IC (vector-instruction class) 2-15
IG (vector-instruction class) 2-13
ILC (instruction-length code) 2-23
IM (vector-instruction class) 2-15
in-use bits 2-4
in saving and restoring 2-28
index
bit 3-12
vector interruption
See vector interruption index
indirect element selection 2-9
load instruction for 3-17
store instruction for 3-37
inhibition of unit of operation 2-22
initialization 2-29
inner product (example) A-3
instruction-length code (ILC) 2-23
instructions
See vector-facility instructions
interruptible vector instructions 2-20
interruption
conditions for 2-25
effect of 2-23
of vector instructions 2-20
priority of 2-27
interruption index
See vector interruption index
invalid vector-register numbers 2-7
IP (vector-instruction class) 2-13
IZ (vector-instruction class) 2-13

L

length of vectors
See vector count
LOAD BIT INDEX vector instruction 3-12
example A-5
LOAD COMPLEMENT vector
instructions 3-15
LOAD ELEMENT vector instructions 3-15
LOAD EXPANDED vector instructions 3-16
example A-6
LOAD HALFWORD vector instruction 3-16
LOAD INDIRECT vector instructions 3-17
example A-5
LOAD INTEGER VECTOR vector
instruction 3-18
LOAD MATCHED vector instructions 3-18
LOAD NEGATIVE vector instructions 3-19
LOAD POSITIVE vector instructions 3-20
LOAD VCT AND UPDATE vector
instruction 3-20
examples A-1
LOAD VCT FROM ADDRESS vector
instruction 3-21
LOAD vector instructions 3-11
LOAD VMR COMPLEMENT vector
instructions 3-22
LOAD VMR vector instruction 3-22
LOAD ZERO vector instructions 3-22
logical data 2-7
loop for sectioning 2-11

M

machine check 2-31
mask bits
bit vector for 2-10
register for 2-1
mask mode
See vector-mask mode
MAXIMUM ABSOLUTE vector
instructions 3-23
MAXIMUM SIGNED vector instructions 3-23
MINIMUM SIGNED vector instructions 3-23
mode
addressing 2-6
architectural 2-6
vector-mask
See vector-mask mode
model-dependent vector functions 1-2
MULTIPLY AND ACCUMULATE vector instructions 3-25
example A-3
MULTIPLY AND ADD vector
instructions 3-26
MULTIPLY AND SUBTRACT vector instructions 3-27
MULTIPLY vector instructions 3-24
examples A-2
multiprocessing considerations 2-1

N

NC (vector-instruction class) 2-19
net count (of vector elements) 2-15
nullification of unit of operation 2-22
number of vector element 2-1
NZ (vector-instruction class) 2-13
NO (vector-instruction class) 2-13
NI (vector-instruction class) 2-13

O

operand parameters (for interruptible vector instruction) 2-21
operands for vector instructions 2-7
operation exception 2-6
OR TO VMR vector instruction 3-29
OR vector instructions 3-28
overflow
 fixed-point 2-7, 2-21
 floating-point exponent 2-21, 2-26

P

parameters
 operand (for interruptible vector instruction) 2-21
 vector 2-1
partial-sum number 2-2
partial sums
 for ACCUMULATE 3-2
 for MULTIPLY AND ACCUMULATE 3-25
 for SUM PARTIAL SUMS 3-40
 for ZERO PARTIAL SUMS 3-41
PER (program-event recording) 2-30
prefetching of instructions 2-30
priority of vector interruptions 2-27
program initialization 2-29
program-interruption conditions 2-25
program switching 2-28
PSW (program-status word) after interruption 2-23

Q

QST instruction format 2-13
QV instruction format 2-13

R

register
 vector-activity count 2-5
 vector-mask
 See vector-mask register
 vector-status 2-2
registers
 floating-point 2-10
 general 2-10
 saving and restoring of 2-28
 scalar 2-10
 vector
 See vector register

resets 2-31
RESTORE VAC vector instruction 3-29
RESTORE VMR vector instruction 3-29
RESTORE VR vector instruction 3-30
RESTORE VSR vector instruction 3-31
restoring of registers 2-28
rounding (vector examples) A-4, A-7
RRE instruction format 2-13
RSE instruction format 2-13

S

S instruction format 2-13
SAVE CHANGED VR vector instruction 3-32
SAVE VAC vector instruction 3-33
SAVE VMR vector instruction 3-33
SAVE VR vector instruction 3-34
SAVE VSR vector instruction 3-34
saving of registers 2-28
scalar iii
scalar operands and registers 2-10
section size 2-1
sectioning 2-11
 examples A-1
sequence of vector operations 2-20, 2-30
sequential addressing of vector elements 2-8
SET VECTOR MASK MODE vector instruction 3-35
 examples A-4
SHIFT LEFT SINGLE LOGICAL vector instruction 3-35
SHIFT RIGHT SINGLE LOGICAL vector instruction 3-35
signed binary integers 2-7
significance exception 2-21
source of machine check 2-31
specification exception 2-26
storage-operand consistency 2-30
STORE COMPRESSED vector instructions 3-36
 example A-6
STORE HALFWORD vector instruction 3-36
STORE INDIRECT vector instructions 3-37
 example A-5
STORE MATCHED vector instructions 3-37
 examples A-4
STORE vector instructions 3-35
STORE VECTOR PARAMETERS vector instruction 3-38
STORE VMR vector instruction 3-38
storing into instruction stream 2-30
stride 2-8
 examples A-2
SUBTRACT vector instructions 3-39
 examples A-2
sum of products (example) A-3
SUM PARTIAL SUMS vector instruction 3-40
 example A-3
suppression of unit of operation 2-22

T

- termination 2-22
- TEST VMR vector instruction 3-40
- three-operand instructions 2-15

U

- units of operation 2-20
- unnormalized-operand exception 2-21, 2-27
- unsigned binary integers 2-7
- updating of vector addresses
 - See address updating

V

- VAC (vector-activity count) 2-5
- valid vector-register numbers 2-7
- validation of vector-facility registers 2-31
- VCT (vector count) 2-3
- vector *iii*
 - bit 2-10
- vector-activity count (VAC) 2-5
- vector change bits 2-4
 - for saving and restoring 2-28
- vector-control bit 2-6
 - effect of on machine check 2-31
- vector count (VCT) 2-3
- vector element 2-1
- vector facility 2-1
 - availability of 2-6, 2-27
 - configuration of 2-6
 - registers of
 - See vector-facility registers
- vector-facility failure 2-31
- vector-facility instructions 3-1
 - classes of 2-13
 - effect of interruption on 2-23
 - fields of 2-13
 - formats for 2-13
 - interruptible 2-20
 - prefetching of 2-30
 - storing into 2-30
 - summary of 2-15
 - three-operand 2-15
 - units of operation for 2-20
- vector-facility registers
 - See also vector-mask register, vector register
 - validation of 2-31
 - vector-activity count 2-5
 - vector-status register 2-2
- vector-facility source (of damage) 2-31
- vector in-use bits 2-4
 - for saving and restoring 2-28
- vector interruption index (VIX) 2-3
 - after interruption 2-25
- vector length
 - See vector count
- vector machine check 2-31
- vector-mask mode (VMM) 2-12
 - bit in vector-status register 2-3
 - examples of use A-4, A-7
- vector-mask register (VMR) 2-1
- vector-operation exception 2-6, 2-27
- vector register (VR) 2-1
 - valid numbers for 2-7
- vector-section size 2-1
- vector-status register (VSR) 2-2
- VIX
 - See vector interruption index
- VMM
 - See vector-mask mode
- VMR
 - See vector-mask register
- VR
 - See vector register
- VR instruction format 2-13
- VS instruction format 2-13, 2-19
- VSR (vector-status register) 2-2
- VSS (vector-section size)
 - See section size
- VST instruction format 2-13
- VV instruction format 2-13

Z

- ZERO PARTIAL SUMS vector
 - instruction 3-41
- zero stride 2-8

Order No. SA22-7125-1

This manual is part of a library that serves as a reference source for systems analysts, programmers, and operators of IBM systems. You may use this form to communicate your comments about this publication, its organization, or subject matter, with the understanding that IBM may use or distribute whatever information you supply in any way it believes appropriate without incurring any obligation to you.

Your comments will be sent to the author's department for whatever review and action, if any, are deemed appropriate.

Note: *Copies of IBM publications are not stocked at the location to which this form is addressed. Please direct any requests for copies of publications, or for assistance in using your IBM system, to your IBM representative or to the IBM branch office serving your locality.*

Possible topics for comment are:

Clarity Accuracy Completeness Organization Coding Retrieval Legibility

If you wish a reply, give your name, company, mailing address, and date:

Note: Staples can cause problems with automated mail sorting equipment.
Please use pressure-sensitive or other gummed tape to seal this form.

What is your occupation? _____

Number of latest Newsletter associated with this publication: _____

Thank you for your cooperation. No postage stamp necessary if mailed in the U.S.A. (Elsewhere, an IBM office or representative will be happy to forward your comments or you may mail directly to the address in the Edition Notice on the back of the front cover or title page.)

Reader's Comment Form

Cut or Fold Along Line

Fold and tape

Please Do Not Staple

Fold and tape



NO POSTAGE
NECESSARY
IF MAILED
IN THE
UNITED STATES

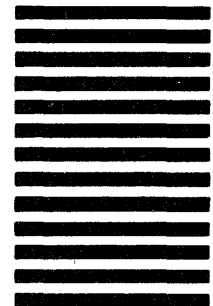

BUSINESS REPLY MAIL
FIRST CLASS PERMIT NO. 40 ARMONK, N.Y.

POSTAGE WILL BE PAID BY ADDRESSEE:

International Business Machines Corporation
Department B98
P.O. Box 390
Poughkeepsie, New York 12602

Fold and tape

Please Do Not Staple

Fold and tape



IBM System/370 Vector Operations (File No. S370-01) Printed in USA SA22-7125-1

Publication Number
SA22-7125-1

File Number
S370-01

Printed in
USA

IBM[®]

SA22-7125-01

